

Building Performance Evaluation

Final report

Non-Domestic Buildings – Phase 2 – Buildings in Operation

Technology Strategy Board BPE ref no:	450041
Project title:	Mayville Community Project
Lead organisation name:	Bere:architects
Building Sector (e.g. retail, leisure):	Architecture
Number of properties part of BPE:	1 (one)

Date:	January 2015
Version:	10 Rev. A
Prepared for:	The Technology Strategy Board
Prepared by:	Lead organisation: bere:architects Data analysis, production of detailed quarterly reports, peer review of final report: bere:architects, Roderic Bunn (BSRIA), Tom Kordel (XC02) Assembly of final report: Justin Bere, Diana Dina, Sara Godinho (bere:architects). M&E services and commissioning: Alan Clarke (M&E), Andrew Farr (ventilation unit commissioning). Monitoring equipment: Hager and BSRIA Peer review and expert guidance: Tom Kordel and Frank Ainscow

Technology Strategy Board Evaluator sign-off	Signature	Print name: ----- Date
	Signature	Print name: ----- Date

Disclaimer: This report, together with any associated files and appendices, has been prepared by the above named Lead Organisation for the purposes agreed in the Technology Strategy Board's Terms and Conditions. Any views or opinions expressed by the Lead Organisation or any individual within this report are the views and opinions of that organisation or individual and do not necessarily reflect the views or opinions of the Technology Strategy Board. While every effort has been made to ensure the accuracy and suitability of the information contained in this report, the results and recommendations presented if used as the basis of design, management or implementation of decisions, are done so at the client's own risk. The Technology Strategy Board does not warrant, in any way whatsoever, the use of information contained in this report by parties other than the above named Lead Organisation.

About this document

This report template is to be used by BPE teams to draw together the findings of the entire BPE process and to record findings and conclusions, as specified in the 'Building Performance Evaluation, Non-Domestic Buildings – Guidance for Project Execution'. The template is designed to assist in prompting the project lead to cover certain minimum specific aspects of the reporting process. Referring to the document 'Building Performance Evaluation, Non-Domestic Buildings – Guidance for Project Execution' will remind you of the elements that should be included in each section. The overall report structure should allow for detailed commentary on the research carried out; explanation of both the hard and soft monitoring undertaken, detailing and evaluation of the findings and rigorous explanation of the lessons learnt. Where further details are being recorded in other reports it is expected these will be referred to in this document. Where translating energy into carbon emissions, ensure common factors / units are used as elsewhere, such as in TM22, to enable common comparisons.

The compilation / authorship of this report is the responsibility of the project lead for BPE. It is not the responsibility of the Technology Strategy Board Evaluator or Monitoring Officer to assist with completing this document. The Technology Strategy Board recognises that the project lead may not have all the relevant information of the specific technical knowledge to complete all sections of the report. It is expected that parts of the report will need to be completed by other members of the project team, however, it is the responsibility of the project lead to manage this process and ensure that the report is robust, with all sections fully completed to a high standard. It is the project leads responsibility to ensure that the report is submitted in a timely manner. Submission of this final report is a mandatory element of the Building Performance Evaluation programme.

Use of illustrations. BPE teams are encouraged to include diagrams, photos and clear sketches where helpful in illustrating a certain point. This can either be in the main body of the report or as appendices. The aim of using various illustrations is to assist with the narrative of the project and give additional understanding to the relevant sections they relate to. Therefore please attribute a caption to all images and ensure that the captions are active and informative (e.g. 'the solar panel was orientated north-south instead of east-west as specified' rather than 'a solar PV panel'). You must ensure you have all the relevant permissions for using images and give the correct credit to the image owner if necessary.

Each section of this report allows for the addition of subheadings, however for consistency reasons do not modify this form without permission from the Technology Strategy Board.

File naming conventions: Please prefix your 10 digit applicant number [xxxxx-xxxxx] to the beginning of the filename when saving and submitting this report. Please remember to update the table of contents [right mouse click > update field] before submitting this report.

Contents

1	Introduction and overview	6
2	Details of the building, its design, and its delivery	10
2.1	Building history before refurbishment.....	10
2.2	Building design strategy	12
2.3	Building fabric and services strategy	13
2.4	Procurement, construction and delivery.....	26
2.5	Passive House Planning Package tool (PHPP)	28
2.6	Conclusions and key findings for this section	29
3	Review of building services and energy systems.....	31
3.1	Ventilation with heat recovery	31
3.2	Ground source heat pump	35
3.3	Photovoltaics array.....	39
3.4	Solar thermal panel	40
3.5	Lighting	41
3.6	Conclusions and key findings for this section	43
4	Key findings from occupant surveys	44
4.1	Interviews with site manager, sub-contractor, MCP managers and board member.....	44
4.2	BUS methodology studies	48
4.3	Conclusions and key findings for this section	60
5	Details of aftercare, operation maintenance & management	62
5.1	Aftercare, operation and maintenance.....	62
5.2	Metering strategy and issues.....	71
5.3	Maintenance and management processes.....	77
5.4	Conclusions and key findings for this section	79
6	Energy use and environmental conditions	80
6.1	Energy use	80
6.2	TM22 analysis	92
6.3	CarbonBuzz.....	94

6.4	Energy and bills costs savings	97
6.5	Environmental conditions	98
6.6	Conclusions and key findings for this section	113
7	Technical issues	115
7.1	Technical issues arising after completion.....	115
7.2	Conclusions and key findings for this section	115
8	Key messages for the client, owner and occupier	116
8.1	Main findings from the study, key messages to the client and occupier	116
8.2	Lessons learnt	117
9	Wider lessons.....	118
9.1	Lessons from the project.....	118
9.2	Messages for other designers.....	118
9.3	Dissemination	122
9.4	Conclusions and key findings for this section	123
10	Appendices	125
10.1	Appendix 1 - Passivhaus Certificate - Mayville Community Centre	
10.2	Appendix 2 - Mayville PHPP Verification page revised hours of use	
10.3	Appendix 3 - Thermal bridging analysis	
10.4	Appendix 4 - Thermography report.....	
10.5	Appendix 5 - Fabric performance report.....	
10.6	Appendix 6 - ALDAS Mayville Acceptance Post-Improvement Air Leakage Test.....	
10.7	Appendix 7 - Submetering report.....	
10.8	Appendix 8 - Monitoring Equipment Installation report.....	
10.9	Appendix 9 - Client Soft landings workshop	
10.10	Appendix 10 - BUS link and explanation	
10.11	Appendix 11 - TM22 report	
10.12	Appendix 12 - Mayville community centre user guide	
10.13	Appendix 13 – Interview with an MCP board member.....	
10.14	Appendix 14 – Telephone interview with the Site manager & Electrical sub-contractor	
10.15	Appendix 15 – Interview with the Centre managers	

10.16	Appendix 16 – Month 18 energy use and environmental conditions report.....
10.17	Appendix 17 - Cost comparison report
10.18	Appendix 18 - Occupancy before and after retrofit
10.19	Appendix 19 - Energy consumption diagram.....
10.20	Appendix 20 – Interview with the Centre manager - November 2014

1 Introduction and overview

This report presents the conclusions of a two year building performance evaluation study (BPE) of the first non-domestic Passive House retrofit in the UK, completed in 2011.

The Mayville Community Centre (subsequently renamed The Mildmay Centre) is located in the London Borough of Islington. It contains a double-height sports hall which is also used for community functions, a reception area, a dining area and a commercial kitchen. There are also office spaces in full time use by tenants in the basement, ground floor and first floor, and a music studio. The building was subject to a complete strip out prior to a general design refurbishment and deep 'fabric first' retrofit.

The retrofitted building has been found to perform very well; generally performing better than designed. It achieved over 90% overall energy savings in its first winter of operation, in which the occupancy numbers were similar to the pre-retrofit occupancy levels. As the building began to attract substantially more users than the pre-retrofit levels, so did the need for lighting and computer power in the new office spaces - and yet with much greater occupancy, the building still maintained over 85% total annual energy savings compared to the pre-retrofit energy usage, and in the winter of 2013-14 it required no space heating while never dropping below 20°C.

Summer comfort during the first and second summers was compromised by the fact that the night cooling vents could not be used due to incorrect wiring of night vents (now corrected) and people also didn't fully understand how to close blinds and open windows for maximum benefit. However the night vents were eventually made operational and, by the end of the second summer, people were used to closing external sunshade louvres while still maintaining light and views. So the BPE project was extended to include a third summer in which a significant improvement was recorded and reported by users. The BUS survey of the summer of 2014 found that summer conditions were considered satisfactory by most building users.

The building was found to be simple and intuitive to use. It is believed that there are only a few buildings in the non-domestic BPE programme without a Building Management System (BMS). The designers deliberately avoided a BMS and maintain that the Passive House design approach is strongly compatible with a services philosophy that tries to avoid the operational and maintenance risks that they perceive to be associated with bespoke BMS systems. The ventilation system and heat pump are controlled mostly by the manufacturers' own standard controls and the aim was to provide an intuitive, user-operated system that does not rely on a building manager to maintain it. The aim was a non-domestic building with little more complexity in its services design than a domestic building.

Through the design of the Mayville Community Centre, the architects have also tried to find out if a deep retrofit can reduce a building's energy demand sufficiently to make an all-electric grid-connected building a viable alternative, in terms of operational costs, to one that burns fossil fuel on site to provide heating (in spite of electricity grid transmission losses). The underlying reason for this interest was the wider question that if a large enough overall energy saving could be achieved by replication of the hoped-for results, would a low carbon electricity grid using largely renewable forms of energy be a viable alternative to one that relies on burning fossil fuel?

The two year study was led by the project architects (Bere Architects), assisted by Roderic Bunn (BSRIA), project M&E consultant Alan Clarke, and ventilation designer Andrew Farr (Green Building Store). Electrician Michael Webber was employed to carry out electrical re-commissioning work and to correct faults in the main contractor's installation of the electrical sub-metering equipment. Tom Kordel (XCO2) was employed by the Technology Strategy Board to monitor the work of the research team and ensure it was carried out objectively and without bias.

The research for this report was carried out in one phase (originally January 2012- January 2014, but extended to August 2014), and encompassed the performance of the fabric, the systems, the energy consumption and the environmental conditions in the building (both recorded parameters, and the perceived comfort of the occupants).



Figure 1-1 The Mayville/Mildmay Community Centre before refurbishment

The original building, a late 19th century electricity generating station was rescued from dereliction in 1973 by the Mildmay Community Partnership. While the basic structure of the building was immensely robust, its fabric remained entirely un-insulated. The building suffered from cold winter draughts and inadequate daylighting. It was expensive to heat and the main hall was cold and inhospitable in winter, with any heat input quickly lost through the corrugated cement roof panels and single glazed, draughty roof-lights.

In 2006 the Mildmay Community Partnership (MCP) asked three architects to prepare proposals to improve and extend the building, at the same time replacing the heating system, possibly with a biomass boiler, and to present their ideas to a Building Users Committee which would chose an architect.

Bere Architects proposed to carry out a Passive House retrofit. This approach was virtually unknown in the UK at the time. They proposed to open up the basement to gain windows and light and thereby get additional office space without needing to build a new extension. The new windows on the south elevation in the basement would flood what were cold and dark spaces with daylight, and along with the new south facing windows at the ground floor and those already at first floor, harvest sufficient warmth from the sun (and occupants) to provide most of the heat required to maintain comfortable temperatures throughout the year. By this means it was argued that the heat demand of the building could be almost completely met, making the net energy requirement so small that the clients proposal to reduce carbon emissions by converting to burning biomass would not be necessary.

The panel of building users interviewed the three architects competing for the project and selected bere:architects with their proposal for a deep retrofit carried out to the Passive House standard. The result was contested at board level because the Passive House standard was hardly known about in the UK at that time and some trustees of the MCP expressed concerns that the design approach was “experimental” and “very risky”. However the decision of the Building User Committee was accepted by the Board.



Figure 1-2 The Mildmay Centre after refurbishment

The winning proposal by bere:architects consisted of the following features:

1. Re-orientation of the building to connect with a restored south garden.
2. Creation of over 30% more room by making the basement into a habitable space with new windows facing into a sunken garden that was to be excavated on the south side of the building.
3. Improvement of the comfort offered to building users by replacing the roof and all the old doors and single-glazed windows, and wrapping the entire envelope in a thick blanket of insulation.
4. Improvement of the accessibility of the building by providing level access throughout.
5. The potential to reduce total annual energy consumption by an ambitious 80%.

The MCP’s proposal to heat the building with a biomass boiler was argued to be unnecessary due to the very small energy demand that would be required by the completed building. On the other hand, if a deep retrofit was not adopted, Justin Bere argued that the building would consume “juggernauts of wood” to cope with the high heat losses of the building.

The decision to adopt the Passive House approach was made in 2006, three years before the first Passive House was completed in the UK. However the MCP had to raise 100% of the funds to do the work, so there followed a delay of three years during which time the detailed design, energy analysis and production information was produced in order to provide material to form the basis of Heritage Lottery and other funding applications.

Fundraising was successfully completed early in 2010 and works started on site in May 2010 and mostly completed in July 2011. When some further funding was found, the kitchen was fitted out in January 2012, and the basement was fitted out by Bere Architects to move into in summer 2012. The music studio, also in the basement, was fitted out during the spring of 2013 and operates on a part-time basis.

This building performance evaluation (BPE) project was carried out using a monitoring plan agreed with the Technology Strategy Board. Roderick Bunn's advice was that the team should use a protocol that could be more affordably replicated in other projects that did not have funding. This was an important and interesting point for Bere Architects who had used a much larger number of automatic data collecting devices on their two domestic research projects in the programme. In this non-domestic project there was greater emphasis on manual sub-metering of electrical circuits. The plan was that if problems were found, then further work would focus specifically on investigating those problems in greater detail. So the following plan was adopted:

- Automatic monitoring of outdoor temperatures and relative humidity.
- Automatic monitoring of a small representative selection of indoor spaces: CO₂, temperature and relative humidity at 5 minutes intervals.
- Manual sub-metering of the electrical circuits including lighting and power used on each level of the building, the ventilation system, and the ground source heat pump, any other electrical consumption, and total electricity use.
- Manual recording of water flow meters.
- Manual sub-metering of the energy produced by the photovoltaic panels and measurement of how much is used by the building, and how much exported to the grid.

The monitoring data was initially recorded via manual readings. At a later stage, indoor temperature, CO₂ and relative humidity sensors were installed in key rooms in the building and pulse counters were added to several sub-meters. This data was automatically uploaded to the BSRIA online database. The data was then downloaded from BSRIA and used by the project lead, together with Roderic Bunn from BSRIA acting as an independent consultant, in order to carry out analysis of the actual in-use performance of the building. This information was compared with the PHPP design data and also the TM22 benchmarking tool and subsequently uploaded to the CarbonBuzz website to allow a rough comparison of its data with the energy performance assessments put there mostly by designers of other buildings, based on sub meter readings which in most cases can only be assumed to be correct.

Additionally, a study was undertaken to assess the occupants' perspective of the building in operation. An official Building User Survey (BUS) was carried out by ARUP who are a licensee of Building Use Studies Ltd. The survey was carried out and assessed by ARUP using BUS methodology (www.busmethodology.org.uk) and included (1) permanent users and (2) transient users who use the building on a weekly basis for various social activities, classes and courses.

2 Details of the building, its design, and its delivery

2.1 Building history before refurbishment

Built in the 1890s as a generating station for London's tram network, the massively constructed building was rescued from dereliction in 1973 by the Mildmay Community Partnership (MCP) and turned into a community centre for the surrounding Mayville Estate. However, by 2005 it was in need of a deep refurbishment. Users found the building cold, draughty, dark and uninviting.



Figure 2-1 Interior view showing the main hall before the retrofit



Figure 2-2 Exterior view showing the south elevation towards the garden

The building had uninsulated, 400mm-thick solid brick walls supported by a concrete frame in the main hall, a leaky asbestos-clad roof, and single glazed, metal framed windows. As a result of its poor quality fabric, it was

very uncomfortable and also suffered from high energy bills amounting to £10,000 a year which formed a large proportion of the total MCP annual turnover of £60,000. Outdated and inefficient mechanical and electrical equipment also contributed to the high use of electricity and gas.

Most of the basement of the building could only be used for storage because there were no windows and ventilation shafts caused cold winter draughts to sweep across the space. Two rooms were used for music studios, but they were quite inhospitable spaces. On the ground floor, there was no connection at all to the South garden and most south facing windows were for service rooms such as toilets and kitchens. The first floor offices were the only habitable spaces that had access to sunlight.

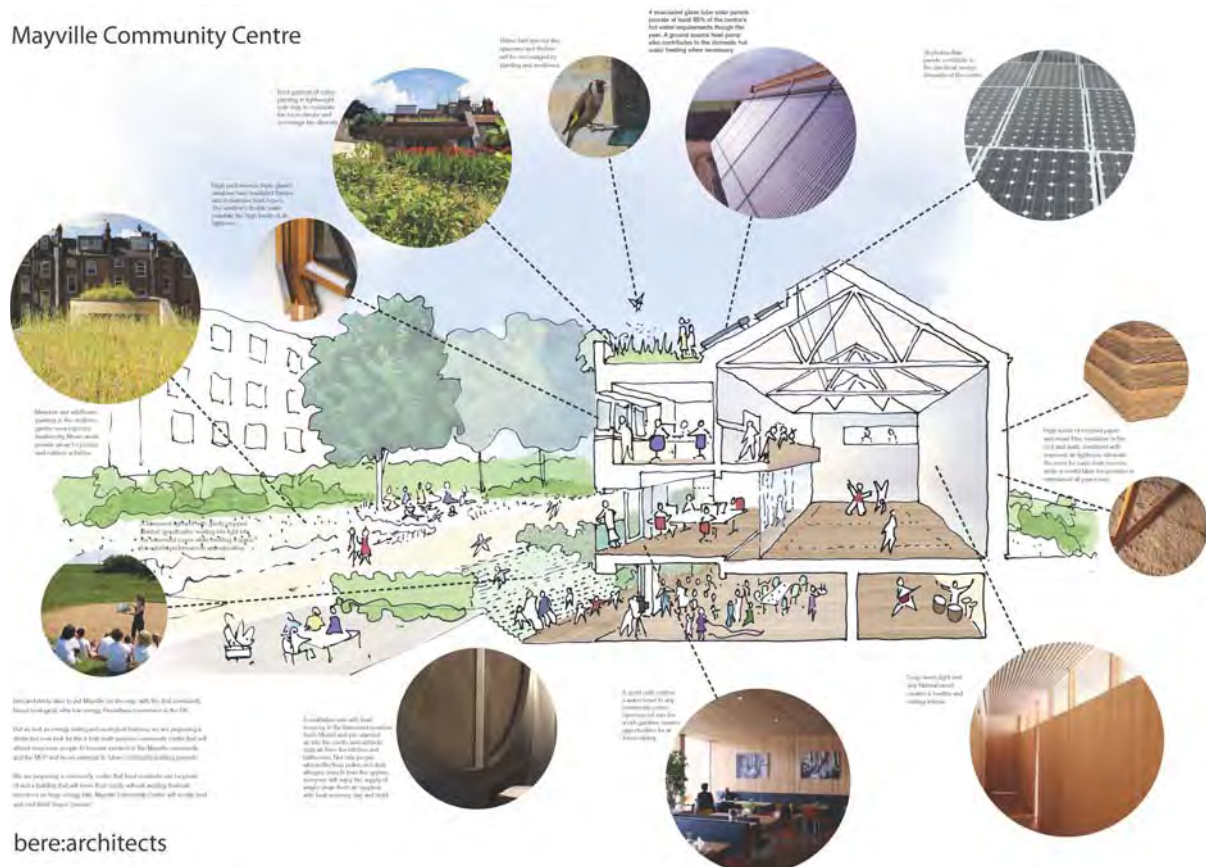

Figure 2-3 Gas boiler and tank in the basement of the Centre prior to refurbishment

2.2 Building design strategy

2.2.1 The approach

Mayville Community Centre



bere:architects

Figure 2-4 A holistic approach to refurbishment

Bere:architects suggested a holistic, sustainable approach to the refurbishment. It was proposed that the building fabric and the building services would be comprehensively improved in order to create much more comfortable spaces while at the same time reducing energy consumption by around 80%.

It was also proposed to include renewable energy to help offset the remaining energy consumption.

Finally, improvements were proposed to the building form and layout. It was proposed to excavate part of the south garden so that the basement could benefit from daylight, solar gains and natural ventilation during the summer via doors to the sunken garden. The previously uninhabited basement is now a good quality office space, contributing a large part of the additional 30% of usable floor space that the building gained through the refurbishment.

The attached single storey entrance block which contained the reception was demolished and rebuilt in a way that better integrated it with the community spaces. Additional space in the entrance area provided sufficient

room for a dedicated dining area with access to a new south garden (formerly locked up and un-used) which was handed over to the community centre by the local authority.

The Passive House Planning Package (PHPP) was used to inform all technical design decisions such as the amount of insulation, the level of airtightness required, the mechanical and electrical systems, and the avoidance of cold-bridging through the fabric of the building. A comprehensive range of features was adopted, as required by the Passive House standard, in order to achieve a high level of comfort (particularly in winter) combined with low energy consumption, such as: much more insulation than would be required by building regulations; super-clear triple-glazed windows to maximise the solar gains during the winter; external louvre blinds to provide the opportunity for summer shading; a passive night ventilation strategy for summer; a draught free envelope that is virtually free of thermal bridges; a heat recovery ventilation system; low energy M&E systems and power generation from clean, renewable energy. Also 11,000 litres of rainwater harvesting storage is provided together with space for wild life to flourish; there are two wild flower meadows at different roof levels, and bat and bird boxes are incorporated within the external wall insulation.

2.3 Building fabric and services strategy

2.3.1 Building fabric – Insulation to walls, roof, slab and high performing windows – key to the fabric first approach

One of the first operations was to externally insulate the basement down to the foundations with 200 mm of high performance (waterproof) extruded polystyrene (XPS) insulation. The walls above ground level were externally insulated with 300mm of expanded polystyrene insulation (EPS) in the form of rectangular blocks glued and mechanically fixed to the external face of the brickwork and finished with a protective hardwearing Permarock render over vandal-resistant mesh at ground level. To complete the basement insulation, 75mm of phenolic foam insulation was added internally on top of the concrete floor.



Figure 2-5 Insulation at basement level

In retrofits, external insulation usually clashes with the location of old rainwater downpipe gullies so alterations to the positions of the gullies are required if cold bridges are to be avoided. In this case there was the additional hazard of a mature tree adjacent to the West gable-end wall. The contractor was very concerned about the narrow excavation that was required between the tree and the end wall of the building, however he

was eventually persuaded that the excavations could indeed be carried out mechanically without the hazard posed to labourers in such confined spaces.

External insulation should always be fitted tightly against the wall it is attached to, in order to avoid thermal bypassing. The importance of avoiding thermal bypassing around the back of insulation blocks has been emphasised by research carried out by Jez Wilkinson (in research carried out at Leeds Metropolitan University). Thermal bypassing can result from only a millimetre or two of air between the insulation and the wall. If an air gap is as much as 3-5mm, this may make the insulation almost completely useless. In the masonry walls of this project, the brickwork was first rendered with a 'parge coat' in order to flatten the surfaces and to make the walls airtight by sealing over any cracks.

After this, proprietary glue was mixed up and applied to the reverse face of each EPS insulation block in a deliberate pattern. The recommended pattern consists of a continuous bead of glue around all four edges of the reverse face of each block, followed by 'criss cross' glue patterns across the same face. Done correctly, the glue pattern prevents any air passing behind the insulation, even if the wall surfaces are not perfectly flat; the worst that can happen is that air can circulate in cracks between insulation blocks. Finally specialist mechanical fixings are applied through the block and capped with insulation plugs to avoid a thermal bridge.

The correct application of the blocks was carefully specified by the architects; however because they were aware of the risk of thermal bypassing, Bere Architects carried out regular and close inspections which on a number of occasions revealed that glue had not been applied correctly. Indeed after repeated complaints about this to the main contractor, finally most of the insulation on the south wall was condemned by the architects when it was found that there was no glue at all behind them; simply mechanical fixings. The specialist subcontractor blamed the problem on communication difficulties across a cascade of sub-contracted site operatives that he employed. This was also a concern on two other projects that the architects were previously involved with, in which external was specified.

All windows were replaced with high quality, German triple-glazed Passive House windows made from engineered wood, with detailing that avoids thermal bridging. Careful attention was paid to both the detailing and the actual installation. The window frames were positioned and levelled with special inflatable bags (Winbags), and fixed with screws that locate but do not put any pressure on the frame that might cause distortion of the frame. The window frames were sealed into the openings with continuous bands of tape installed in a particular way established after years of research in Germany. To ensure that contractors could follow instructions, the architect generated multiple work stage drawings for complicated junctions.

A replacement zinc pitched roof with 400 mm of insulation was installed over the top of the existing steel trusses. A layer of 300 mm Rockwool insulation was placed between the joists, with 100 mm of denser Rockwool over the top of the steel structure to avoid cold bridges. The top of the insulation is covered with a Tyvek breathable membrane and finished off with a standing seam zinc roof.

Openings to the ground floor south elevation were enlarged to allow access to a balcony connecting to the south garden, increasing winter solar gains. At the same time the south basement wall was opened up by means of a sunken garden; a small amphitheatre shaped space that is connected to the main garden by a planted slope. Floor to ceiling double doors allow natural light and solar gains to enter the large south facing area of the basement. This enhanced the building's capacity, creating a large space with ample daylight and direct access to the garden.

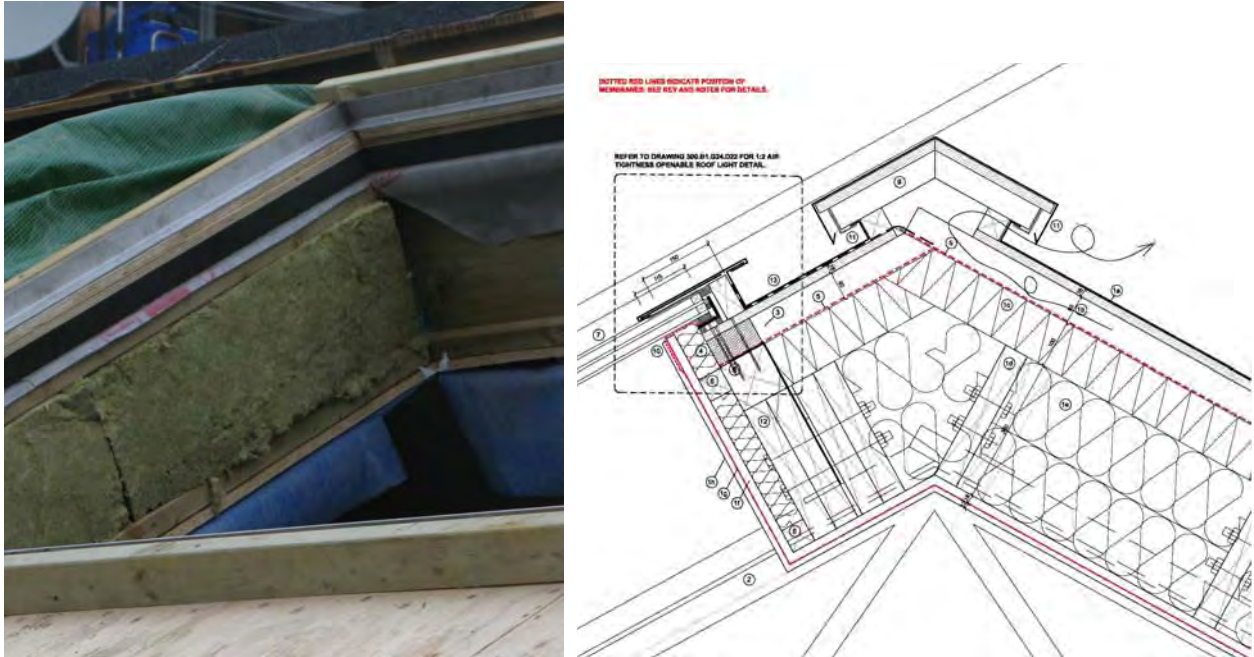

Figure 2-6 Roof insulation and detailed construction drawing



Figure 2-7 Steel posts with thermally broken connections (by Schöck) for the basement openings

2.3.2 The Extension

An enlarged single-storey entrance block with a reception and dining area was added, and for the first time the public areas gained access to the garden. Extra space in the reception areas, together with extra space in the basement, has combined to increase the usable area of the building by about 35 per cent. The treated floor area after retrofit is 665 m².

The extension was constructed from 215mm thick concrete block walls and insulated with 290mm expanded polystyrene external insulation. A 200mm thick reinforced concrete slab was poured over 300mm of Foamglas Floorboard insulation. The green roof over the reception was insulated with 300mm of Foamglas insulation slabs.

To provide maximum accessibility and security for staff, the new front door is electrically operated with a button release at the front desk to let visitors in, and a button release either side of the front door so users can let themselves out of the building. However the door opening and closing mechanism (manufactured by the German company Geze) was not properly commissioned by the contractor with the result that for the first two years, the front door would not close properly. As a result, the receptionists sometimes complained of cold temperatures in the winter. The German door manufacturer insisted that the door closer they supplied from Germany was the correct product and powerful enough to close the door, but the sole UK distributor of Geze door closers, asked to commission the closer, said that either the door or the closer was faulty and needed to be replaced. It was not until the German door manufacturer obtained detailed installation instructions from Geze in Germany, that it could be established that the door closers contained a closing pressure adjustment bolt, something that Geze UK had consistently denied. It was not until the German door manufacturer visited the UK and showed Geze UK exactly how to commission their door closer correctly, that the problem was eventually solved in March 2014. The front door has closed faultlessly since this adjustment was made.

However it is noted that centre management and staff frequently choose to smoke outside the front door and rather than use a key to let themselves back in, leave the front door on 'hold open' while they are smoking. This results in noticeably cooler temperatures for a period of time afterwards. Various solutions are being considered but it is too early to draw lessons from this.

2.3.3 Heat 2 analysis of details during the design stage to avoid thermal bridges

All key junctions were analysed in order to avoid thermal bridges. The design team used the Heat 2 software to evaluate the heat losses in critical locations. The software gives useful information at design stage regarding the heat flow, the temperatures within the element build up (which enables the designer to evaluate the risk of surface condensation if any internal surface reaches the dew point temperature), and the linear thermal transmittance (Psi value). The Passive House standard requires that the external cold-bridging Psi value is < 0.01W/mK

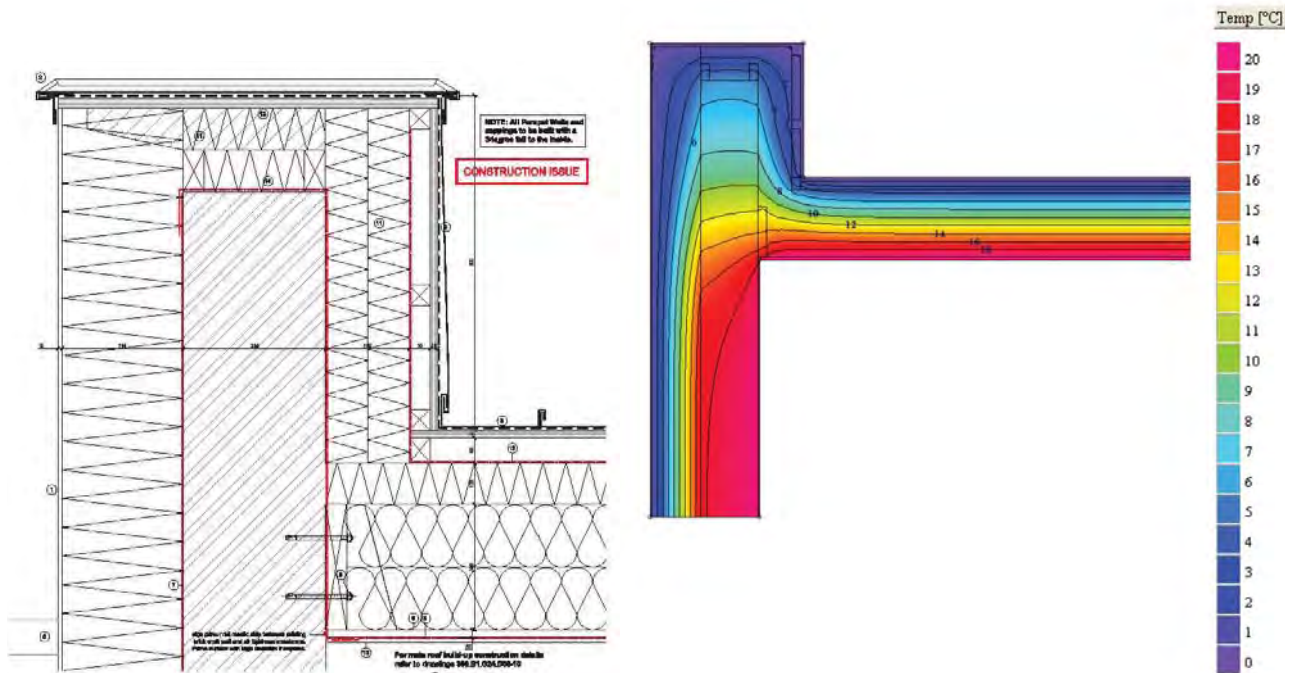

Figure 2-8 Heat2 analysis of roof parapet

After completion of the roof construction it was noticed that thermal bridging might occur in one of the eaves of the existing building roof (detail below) where the junction between the wall and the roof insulation was left uninsulated due to an error in a drawing. This problem was rectified by using sprayed expanding foam to fill the gap in the north elevation eaves line, in the void found between the top of the EPS insulation boards and the plywood substrate to the zinc roof.

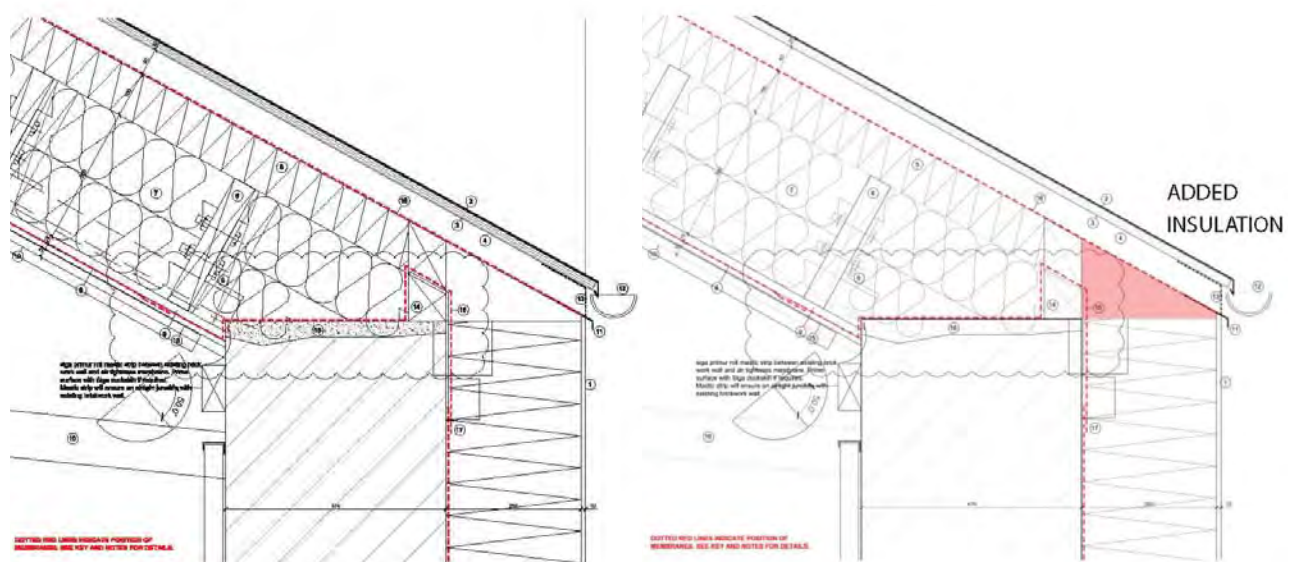

Figure 2-9 Heat 2 analysis of roof eaves

The heat 2 analysis of the 'before' and 'after' solutions show the heat flow through that detail without insulation, and then with added insulation creating a continuous thermal envelope (the 'tea-cosy effect') which is one of the key features of Passive House design.

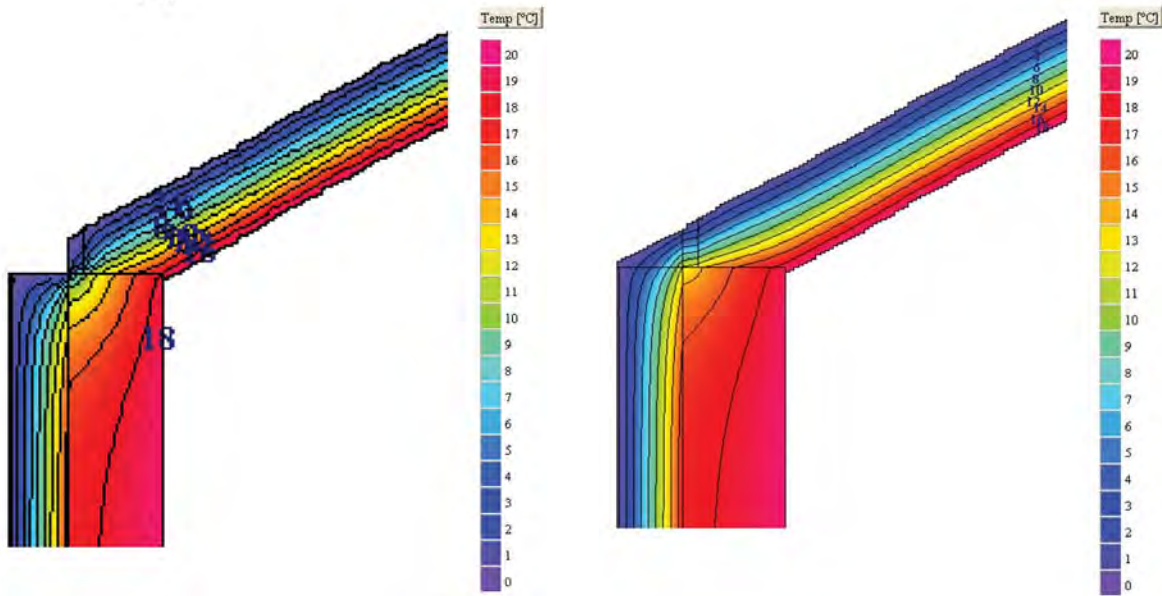

Figure 2-10 Heat 2 comparison of heat flows through insulated and insulated edge detail of roof eaves

The location of the windows within the wall build up should be carefully detailed to avoid cold bridges around the window frame. By moving the windows outwards from their original position, into the line of the external insulation, the masonry structure is completely enveloped and a cold bridge is avoided. At the same time, the full size of the original window is maintained, and the depth of the window recess can be maintained to match the window depth, viewed externally, before the retrofit.

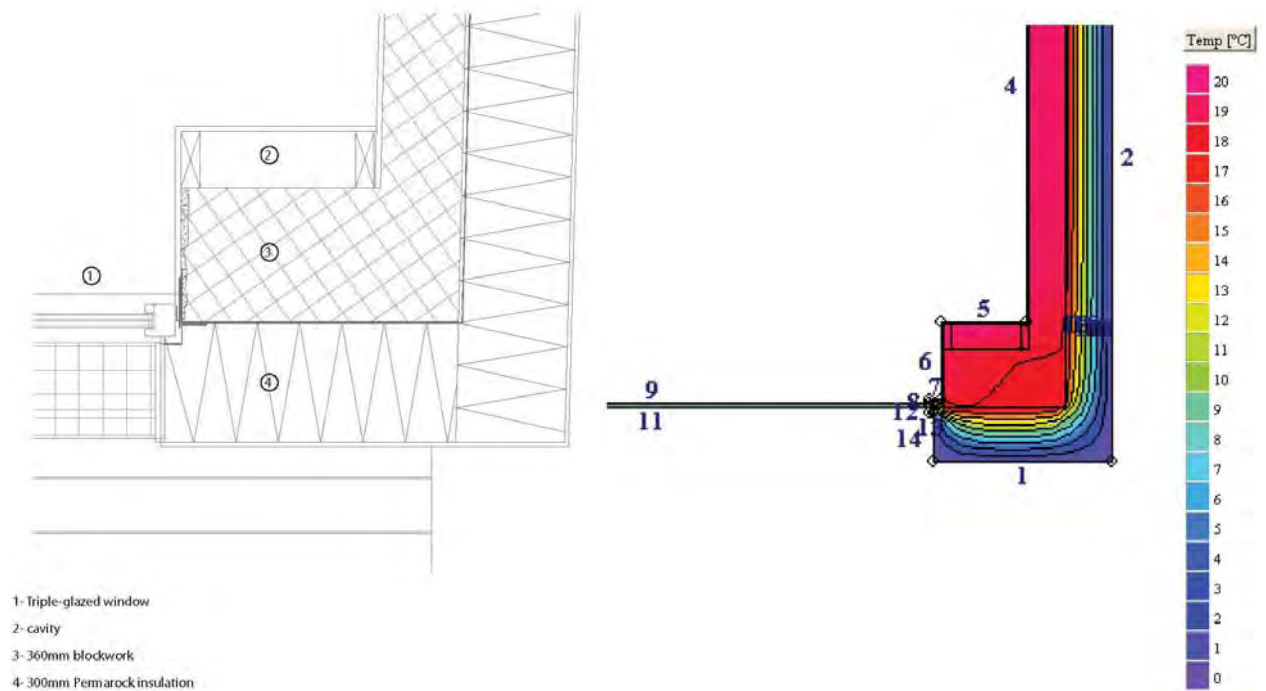

Figure 2-11 Heat 2 analysis of extension wall and window connection

Preparation for external insulation: the new windows are fitted proud of the wall and the edges of the frames will be wrapped in insulation to reduce the glazing sight lines.



Figure 2-12 Location of windows into wall build-up

The full detailed thermal bridging analysis is attached to this report in Appendix 10.3, and a full fabric performance report is presented in Appendix 10.5.

2.3.4 Airtightness

Draught-free construction is one of the key features of a Passive House building, therefore special attention is paid to this both during design and construction. The design team found on their first Passive House project in London, the Camden Passive House, that having an ‘airtightness champion’ on site is very important, and that spending time with the contractor on site to explain how to achieve a good airtightness level pays off in the quality of the finished building.





Figure 2-13 Airtightness tapes around windows (previous page) and thinking ahead with membranes fitted to rooflights and trusses in readiness for later connection to the main membranes.

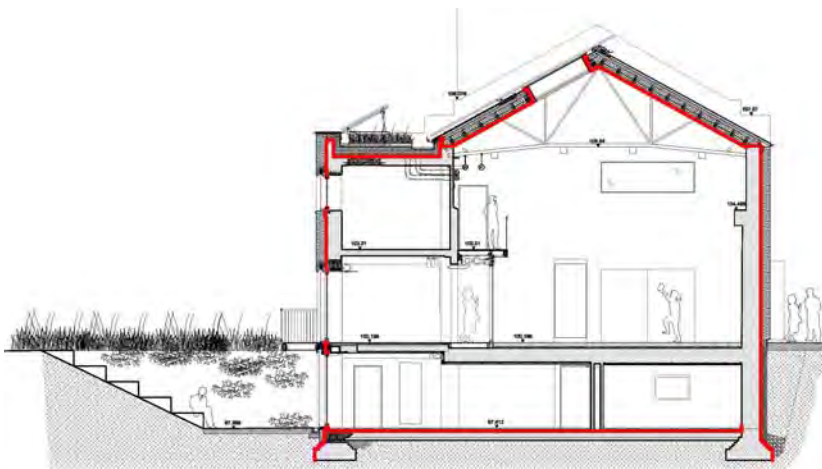

Figure 2-14 Section showing the planned airtightness layer highlighted by means of a red line

In order to achieve a draught free construction, it is paramount to take into consideration the airtightness layer from the early design stages and clearly mark it on construction drawings. The airtightness layer in this project was created by applying a parge coat (a cementitious render) on the external face of the solid brick walls, which was then connected via special tapes to the windows and doors, and to the roof membrane.

Two airtightness tests were carried out; the final test achieving a value of $0.43\text{m}^3/(\text{h}\cdot\text{m}^2)$ @ 50pa – This result is more than 10 times better than the requirements of the UK Building Regulations and meets the Passive House requirement. It is a remarkable air tightness to achieve in a 19th Century building but the architects are confident that such results are replicable at scale. The full airtightness record is attached in Appendix 10.6 at the end of this report.



Tel: +44 8456 808048
Mob: +44 7866 948200
www.aldas.co.uk
Info@aldas.co.uk

Acceptance Post-Improvement Air Leakage Testing Report

Site Address: Mayville Community Centre, Stoke Newington, London N18 8NA
Test/Job No: ALD10-05-0221
Test Date: 30th June 2011
Test Engineer: Paul Jennings, ALDAS Limited
Customer: Peter Dean, Buxton Building Contractors



Address:	Mayville Community Centre	Target
Air Change Rate (ACH ⁻¹ @ 50 Pa):	0.42	≤ 0.6
Air Permeability (m ³ /hr/m ² @ 50 Pa):	0.93	n/a
Air flow exponent, n-value:	0.64	0.5 < n < 1.0
Correlation coefficient, r ² -value:	0.996	r ² > 0.98

Figure 2-15 Airtightness test report – first page

2.3.5 Building services

- General approach: The design team wanted to reduce energy consumption to the minimum while keeping control of capital costs. Also because there is no services manager to run the building, it was an important design consideration that the systems are easily managed and maintained.
- Ventilation: It was successfully argued that heat recovery ventilation should be recognised as a low carbon technology, and the technology was therefore considered eligible to be part-funded by the

Islington Climate Change Fund that the council had set up. Part funding was also provided by the same fund for the heat pump and photovoltaic array.

The Paul Maxi 2000 heat recovery unit is sized to deliver 8.3 litres/s of fresh air per person for the offices, and 5.6 litres/s of fresh air per person for the hall and dining area. The specific fan power of each of the supply and extract fans is 1.86 W/l.s. Heat recovery is via a cross flow heat exchanger, said to deliver close to 90 per cent heat reclaim. The fan motors are in the supply airstream, which ensures that the heat generated by the motors is not wasted. The unit is a 'constant pressure' unit, which means that if additional air supply valves are opened up in response to high occupancy levels, the Paul unit will automatically ramp up the amount of air it supplies to maintain a constant pressure of air supply at all outlets.

The ventilation strategy follows the important rule to 'ventilate the people, not the building'. In other words, the ventilation runs only during hours of occupation, conserving energy when the building is not occupied. Steady rates of ventilation are provided throughout most of the building in order to reduce the need for CO2 sensors, but CO2 sensors are used in the two spaces of widely variable occupancy; the main hall and the dining area. The time control is a simple programmable timer typically used for a domestic central heating system, which was set to run the unit from 7am to 9pm daily.

After the building was in use, the designers realised that there are occasional events, such as parties, booked in the main hall which can run until late in the evening. Clearly ventilation is needed for these events, and the design team installed an easily accessible ventilation override button to boost the hours of ventilation upon demand. This is located at the bottom of the main staircase. This enables whoever is on duty to extend the running time of the ventilation during late events by 30', 1h, 1h ½, 2h, 2h ½ or 3h.

Given a small additional budget, Justin Bere would also like, with hindsight, to fit a presence detector in the entrance area, connected in such a way that it would automatically switch on the ventilation unit for 30 minutes, to ensure ventilation is provided during large late evening events, in case the centre management fail to manually extend the ventilation hours by means of the switch at the bottom of the main staircase.

The building services strategy was to keep the ventilation running as one zone, so the controls have been simplified to match this requirement. The ventilation system extracts air from the kitchen, the dining area, the bathrooms and the main hall, and supplies air in the reception area, dining room, main hall, and office spaces.

There is also a separate ventilation system for the music studios which was installed by MCP after completion of the building, but this does not meet the design criteria specified by the design team. As a result, the music studios are under-ventilated.

The summer/winter ventilation strategy of the main ventilation system is described below:

- Winter ventilation: In the winter the building services follow a full mechanical 'hygiene' ventilation strategy, with the system providing both fresh air supply and air extract. Under normal occupancy

cascade ventilation is utilised with the main hall using the air flowing back across from the cellular office spaces to the main extract cowl in the main hall. Under high occupancy, if the CO₂ sensors in the main hall or the dining space sense CO₂ above 1000ppm, a valve will open in supply air ducts to the affected room. This will result in fresh air being supplied directly to the space. The additional flow of fresh air lowers the CO₂ levels in the air to approximately 800ppm at which point the air supply closes and the system reverts to cascade ventilation.

Motion sensors in the offices on the first floor operate in the same way.

In the kitchen an intelligently controlled extract hood, independent from the ventilation system, provides a means to clear cooking smells. The extractor hood's own advanced control system operates dampers on the external face of the building which close to maintain air tightness when not in use, and provides re-circulation for heat recovery when weather conditions indicate the need for this.

- Summer ventilation: During the summer time, the building works in a mixed-mode strategy which combines some mechanical ventilation to ensure bathrooms are properly ventilated, with natural ventilation to provide the relatively large volume of air movement that is required for summer cooling.

Openable windows provide natural ventilation throughout the building in summer. Mechanical ventilation is supplied to just the basement and first floor offices, balancing the extract ventilation from all the wcs (originally 5 wcs were planned in the basement) and the kitchen in the event that the windows are all closed.

The boost ventilation triggered by the CO₂ and motion sensors during the winter is disabled during the summer.

During the summer, the cooling strategy relies on the use of the rooflights in the main hall and a ventilation grille next to one of the main hall fire exit doors to provide night purge cooling. Additionally, there is a benefit in leaving windows on tilt on a warm summer night in the top floor offices.

Additionally, an automatic summer bypass around the heat recovery exchanger in the ventilation unit ensures that heat in the warm air extracted from the building is not transferred into the fresh air supply except during winter months.

- Switching between summer and winter ventilation: Switching between the two ventilation strategies is currently done via a summer/winter switch located in the plant room. With hindsight it seems likely that the seasonal operation of this switch may be overlooked by the centre staff. Automation of this switch would therefore be preferable, by means of a calendar switch.

Less satisfactorily, it would be possible to leave the switch set to winter all year round, since the additional electricity consumption would not be large. As mentioned later in the report (Chapter 6 Energy

Use), the monitoring data indicated that the energy used by the building systems is very low, therefore using the winter strategy (including CO₂ sensors to boost the air) throughout the entire year would not have a large impact on the overall energy consumption of the building (see figure 6-9 which

does not indicate much difference in seasonal energy use of the ventilation unit, even though the Summer-Winter switch was operated throughout the monitoring period). The boost switch would probably not be activated by elevated CO₂ levels in the summer months because users habitually open the windows in the summer.

However if the system is left on a winter setting, it is thought that the summer bypass would not be switched on, and the system would then be recovering unwanted heat within the air stream. So the calendar switch mentioned above is certainly preferable, and something that will now be explored. A lesson learned here is that in spite of the low-tech design philosophy, a small degree of user-friendly automation will probably help ensure such buildings run optimally in the event that there is no building manager.

- Ground source heat pump: Grant funding favoured the 8.4 kW Viessmann ground-source heat pump rather than the option of a small domestic gas boiler. The services designer, Alan Clarke, would have preferred the conventional solution of a domestic gas boiler which would have been enough to provide the small top-up heating needed in the building.

However the heat pump in this extremely energy efficient building proves that an all-electric building can have a very low electricity demand and the reader can draw their own conclusions with regard to the compatibility of such an approach with a low carbon electricity supply powered largely by renewables.

The heat pump also provides top-up for the 300 litre domestic hot water tank which is connected to a single 3m² Viessman solar thermal vacuum tube panel.

The GSHP buffer storage for space heating is sized at 200 litres. The tank temperature was not automatically monitored however it was inspected almost daily in cold weather and while accurate records were not kept, the tank was almost always found to be unheated because there was little requirement to heat the building (see chapter 6).

Standard radiators, sized for a 45°C flow, have been installed in case of any space heating that may be required. Decoupling space heating from the air supply allows the mechanical ventilation to be turned off, reducing electricity consumption, while allowing heating to continue if it were required outside hours of occupancy.

Detailed information about these systems can be found later in Chapter 3 Review of building services and energy systems.

- GSHP controls strategy: There is one thermostat in the main hall, no different to a domestic heating thermostat, which is connected to the GSHP. Any heat called for is supplied to low temperature radiators with thermostatic valves.

It is worth noting that when the architects' own office was fitted out in the basement area, the radiators were removed and the basement office has no means of space heating at all. Due to internal gains from the staff, computers, screens, and their server, comfortable temperatures were maintained throughout each winter. Even in the early hours of the coldest Monday morning of the

exceptionally cold winter of 2012-13, after the office had not been occupied over the weekend, the internal temperatures never dipped below 19.75°C.

In the summer the GSHP provides backup heat for the solar-powered domestic hot water requirements (details in Chapter 3).

- Electric lighting controls strategy: Electric lighting is operated on the principle of
 - Manual on
 - Manual off
 - Presence detection to automatically switch off when forgotten
 - Daylight dimming was specified, but disabled due to a cost-saving change to non-dimmable light fittings.

The design team has paid some attention to lighting controls that save energy while giving the users a sense of full control. To this end, the team opted for a simple manual on, manual off approach, with auto off if forgotten; so PIR-based absence detection is used (rather than presence detection which is reserved for wc's only). However, as discussed further in Chapters 3 (Review of building services) and 4 (Details of aftercare, operation, maintenance & management), the lighting controls suffered from poor installation which made correct commissioning impossible to achieve.

MCP carried out post-contract installation of lighting in the storage areas at the foot of the back stairs without any switching controls at all, contrary to the design specification. The result is that the lights in this area are left switched on 24/7.

The building's lighting consists of a mixture of conventional T5 and compact low energy fluorescents.

- Water use strategy:

In order to minimise the amount of mains water used in the building, it was decided to use a rainwater harvesting system which allows the re-use of rainwater on site from the two roofs:

1. main (zinc clad) roof - used for WC flushing.
2. green roof - used for garden irrigation.

- Rainwater storage:

Located under the garden terrace deck there is:

1. An underground rainwater tank collecting water from the main (zinc) roof, (plus a manhole for the filter next to it); it is connected to a pump (supplied by Aquality) located in the plant room which supplies the water to the toilets. When the rainwater is not enough, the system provides water from the mains connection. When the rainwater collected exceeds the capacity of the tank (5000l), it overflows to the neighbouring tank (6500l) which also collects water from the green roof above the reception area.

The system does not help an un-trained user to easily establish whether the pump is supplying rainwater or mains water to the toilets. A pump failure resulted in the system being switched to mains and the system as designed relies on maintenance checks to ensure it is operating correctly. A simple alarm on the system, or a red flashing light, would be a good refinement of the design of this reclaimed water system. More information about the operation and maintenance of the system is given in Chapter 3; Details of aftercare, operation, maintenance & management.

2. An underground rainwater tank collecting water from the green roof, which has its own immersed pump, with its own power connection, and its own filter located at the top of the tank which needs to be cleaned from time to time. This tank provides rainwater to irrigate the garden, through water taps located in the garden and on the side of the garden terrace. When the rainwater is not enough, it stops supplying water to the taps. When the rainwater collected exceeds the tank's capacity (6500l), it goes to an overflow area located in the garden.
3. One manhole which houses a 'water collection' area from the green roof before going into the rainwater tank.
4. Another manhole located also under the terrace, near the kitchen door, where there are several manifolds and a protected power socket which powers the pump from the green roof rainwater tank going to the garden taps. This socket needed to be disconnected and re-plugged on several occasions to re-set the garden irrigation pump within the tank and re-establish the supply of recycled water to the garden. In the meantime the users of the garden watered the plants using mains water. The cause of this problem has not been identified.

2.4 Procurement, construction and delivery

Procured under the JCT SBC/Q05, refurbishment works to the building include internal space re-planning to create an extra 35% usable space for both local community use and renting out to suitable local businesses. The building's accessibility was improved and a full upgrade of the fabric and its environmental systems was planned to meet Certification to the Passive House standard. The construction budget was £1.6 million.

2.4.1 Funding, grants and donations

Grants came from numerous sources including the Big Lottery Fund and the Islington Climate Change Fund. Priorities of the latter fund include achieving:

- Significant carbon savings
- Benefit to residents

The project was presented to Islington Council as a unique opportunity to refurbish a building to the full, certified Passive House standard and reduce building emissions by 84 per cent. Islington's advisory panel considered the application (including the request to fund mechanical ventilation and heat recovery - HRV) and

approved a grant for the renewable energy and ventilation equipment, based partly on the fact that the heat recovery ventilation plays a crucial part in reaching the target emission rate. It was also successfully argued

that the Heat Recovery Ventilation system (HRV) was required to enable the low energy strategy to be operated successfully with a small domestic Ground Source Heat Pump (GSHP). Because the HRV was intrinsic to the size and cost of the renewable technology and enabled a high percentage reduction of carbon dioxide emissions, the grant was approved.

Requests for a grant to fund the triple-glazed windows and high specification insulation were not accommodated. This is largely because the executive report which relates to Islington's Climate change Fund (CCF) states: *"All projects [are] subject to the installation of energy efficiency measures necessary to maximise carbon savings from renewables"*.

The CCF conditions do say, however that: *'Where a case can be made that finances don't permit this, and all other grants have been applied for, the Advisory panel may recommend to the executive that approval be given for energy efficiency measures that maximise the carbon savings from the building.'*

2.4.2 Budget constraints: low energy features vs. finishes

The Mildmay Community Centre retrofit relied on funding and donations from a number of sources including the Big Lottery, City Bridge Trust, Community Builders Fund, the Department of Energy and Climate Change, London Borough of Islington, and other private donors. Some important funding (in the region of £100,000), which had been offered by the leader of the Lib-Dem council leader's discretionary fund was subsequently lost after Labour won leadership of the Council. In spite of this loss of funding, it was decided to maintain the Passive House standard of the building. Items removed from the contract due to loss of funding included:

- Painting, plastering, and carpentry work (done by the community)
- Kitchen mechanical and electrical fit out (paid by a private loan)
- Interior glass partitions (paid by a private loan)
- Timber decking to the South garden (paid by a private loan)
- Fit-out of basement offices (paid by a loan from Bere Architects)
- Basement music recording studios

The majority of the affected works were able to be carried out in smaller packages outside of the contract, as and when additional funds have become available from various donors. The removal of these works from the contract caused disruption, but changes to the fabric performance specification would have been much more expensive and intrusive to retrofit post-contract, and in all likelihood would never have been done.

An additional benefit of taking out small individual packages of works concerned the psychology of fundraising. In practice it is often much easier to approach funders for help with smaller tangible items, where they will clearly be able to see how their money has been used. Raising money for incremental fabric improvement measures would likely have proved more difficult.

A provisional sum for monitoring equipment was removed from the contract. The metering equipment which remained was designed and installed by the M&E subcontractor, in order to meet the minimum requirements of the *Building Regulations*. Due to the need to omit the provisional sum for monitoring equipment from the contract, the sub-meter layout did not initially provide all the information needed for monitoring of the building, such as the full GSHP consumption, nor the PV net export to grid. So in order to better explore both the energy and environmental performance of the building and for the TSB study to provide the best information possible, the following equipment was installed:

- extra sub-meters (monitoring the energy consumption of the GSHP, PV export to grid, and power in the basement offices)
- pulse counters
- temperature sensors
- relative humidity sensors
- CO2 sensors

2.5 Passive House Planning Package tool (PHPP)

The occupancy of the building is higher than expected. After the completion of the project most of the rooms on the ground floor and 1st floor, which were intended to be used for occasional meetings or weekly events were rented out by the Centre and became used as offices, with office equipment added (screens, computers, printers, servers). Also Bere Architects rented out the basement to be used as an architects' office.

As a result of the higher occupancy and the fact that several different organisations rent out offices in the building, each with their own servers (a total of 7 servers run 24/7), it was found that the lighting and small power (IT and other equipment) represent more than 85% of the building's energy consumption. (More detail in Chapter 6 Energy Use and Environmental Conditions).

The heating and hot water demand predicted by PHPP was only 13kWh/m²/yr. However the monitoring found that the actual heat load in the second year of monitoring was much lower than expected (approx. 2kWh/m²/yr). This is because the higher than expected occupancy resulted in higher than expected internal heat gain from office equipment, and the heat from this office equipment was sufficient to satisfy the building's low heat demand.

The electricity used by the building systems (GSHP, ventilation unit, solar thermal and rainwater harvesting pumps) was estimated at 3.2kWh/m²year by PHPP. This compares very closely with the metered data of 3.7kWh/m².year during the second year, by which time the direct heater was connected inside the GSHP. (Note these figures are grid energy usage and the GSHP grid usage is subject to multiplication by its coefficient of performance which is expected to be between 3 and 4 for delivered heat energy).

2.6 Conclusions and key findings for this section

The main conclusion drawn by the team were:

1. The design strategy focused on a fabric first approach, with low energy systems, a single zone services design, and simple controls.
2. The building was carefully detailed to ensure all key junctions are thermal bridge free as required for Passive House certification.
3. The airtightness strategy was carefully thought through by the architects and clearly noted on plans and sections. The architects help ensure the contractor's programme was properly organised around the three staged air tests. A one day training course was arranged at the start of the project for the site manager and other construction staff. Regular on-site training, practical advice and inspection by the architects ensured the contractor successfully achieved an excellent air test over 10 times better than required under UK Building Regulations. The result is a thoroughly draught free and high quality, energy saving envelope.
4. The Passive House Planning Package (PHPP) and heat transfer calculation software (Heat 2) were used to check the performance of the building and to check and optimise details.
5. The services strategy was kept as simple and straightforward as possible. Although for a Passive House a heat recovery ventilation and a minimal top-up heating offered by a simple boiler would have sufficed, the grants and funding available led to the use of a ground source heat pump and the integration of two photovoltaics arrays which contribute to entirely cover the building's net electricity use (regulated use, including lighting but excluding user socket loads).
6. Difficulties with funding led to the Centre owing money to the main contractor, which in turn meant that the snagging list is only slowly being addressed. This included rain sensors not connected to the main hall roof lights, thus preventing the full operation of the building's cooling strategy until summer 2014, and various problems such as the front door not closing properly for the first two years resulting in winter draughts in the reception area, problems with controlling some of the lights, electric wiring, metering, labelling, etc. These snags have only been overcome by the persistence of the design team in insisting that installation and commissioning errors were corrected.
7. In spite of the problems with the tight budget, the centre manager at the time, employed by the Mildmay Community Partnership, decided to postpone some of the works related to finishings, rather than compromise on the low energy features of the building.
8. The PHPP design estimate regarding the energy consumption of the system is very close to the metered data, however the client's estimations regarding the occupancy of the building (and therefore associated lights and IT and small power equipment were) have changed after the completion of the

works. The building is now mixed-use, with almost 30% of the total 800m² gross internal area being used by offices.

9. Doubts at MCP board level about the viability of the design approach meant that the project may not have proceeded without the persuasive skills of two key MCP members. At the same time, funding was largely dependent upon the high ambitions of the project to save energy.

3 Review of building services and energy systems

3.1 Ventilation with heat recovery

3.1.1 Ventilation system schematic

The heat recovery ventilation unit is a Paul Maxi 2000. Its controls are located on the outside of the casing; linked to a programmable timer located in the plant room, and a summer/winter mode switch, also located in the plant room.

The system layout and controls are described in the M&E design schematic below. The team has monitored the fan and controls, and the 6kW pre-heater separately. As explained in Chapter 2.3 *Building fabric and services strategy*, during the winter the building works in mechanical ventilation mode, with full supply and extract, and boost ventilation based on CO₂ sensors in the main hall and dining area, and motion sensors in the offices. During the summer the mixed mode ventilation strategy relies on openable windows, while the unit provides extract to kitchen and bathrooms, and supply locally to the basement open plan area (now the architects' office) and the 1st floor office at the top of the stairs. However, due to the fact that a damper valve became faulty and was subsequently not replaced, the damper for the 1st floor offices remained permanently open on the supply duct, thus providing constant supply to the 1st floor offices in the summer as well as during winter. The faulty damper valve was spotted when users heard the valve shutting and opening repeatedly. The valve had not been replaced by the sub-contractor at the time this report was written.

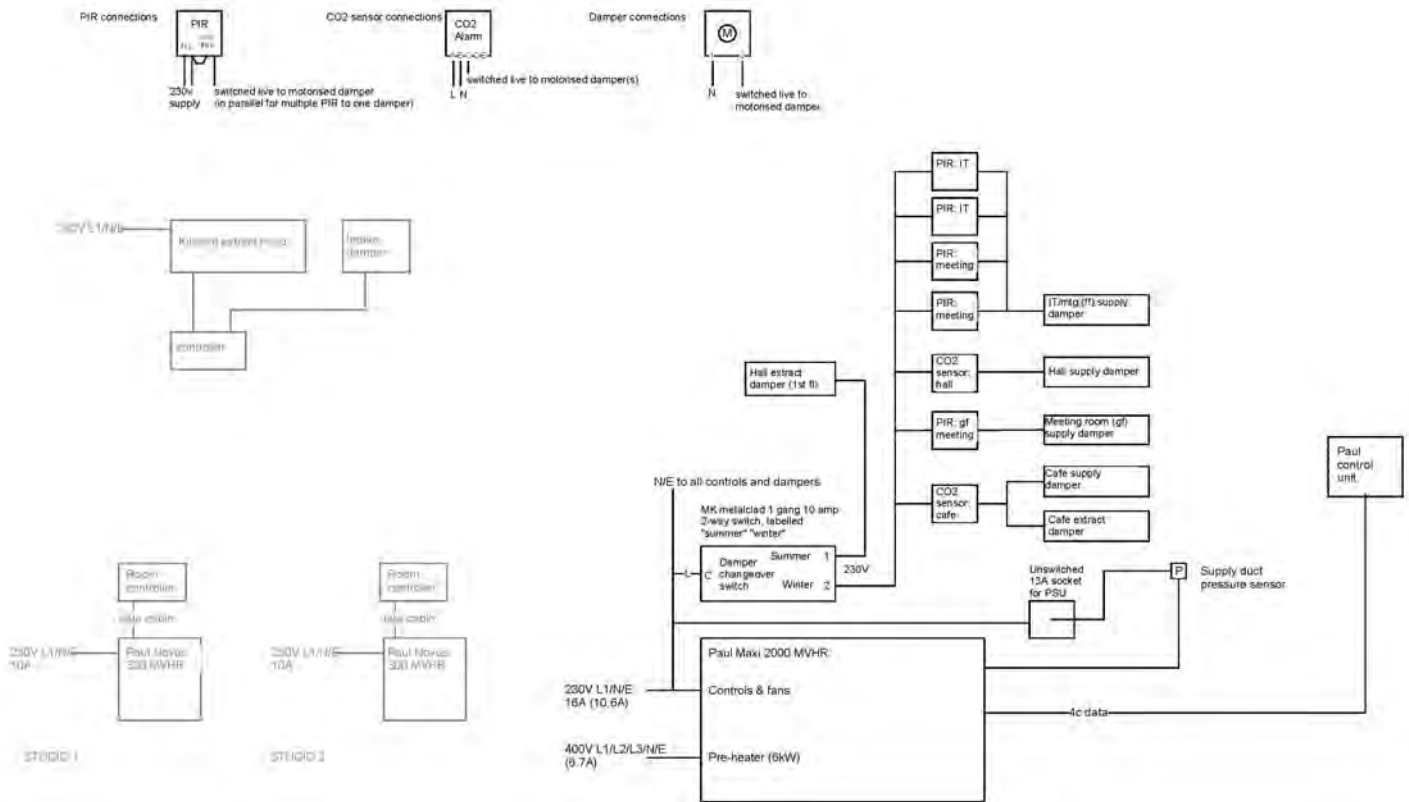

Figure 3-1 Ventilation schematic

The music studio rooms in the basement were designed to have separate ventilation units to be added in at a later stage. The ductwork was laid in place for the future, with intake and exhaust ducts located in two former ventilation shafts on the northern side of the building. During the fit-out works which took place in April and then October 2013 2no. Vent-Axia through the wall units were installed by the centre management. The first option was a cheap 'bathroom extract' option which would not function correctly for technical reasons, and this was replaced with better, but still under-powered heat recovery ventilation units in each of the two rooms of the music studio (live recording room and controls room). The change occurred only after the design team prompted the centre management.

The controls display for the main ventilation unit is located on the casing of the ventilation unit in the plant room, and the team added labels to explain the commissioned settings:



Figure 3-2 Ventilation unit – controls display (plant room)

The summer/winter damper switch located in the plant room switches between the winter and summer strategies (figure below). There was no label to suggest what the 'summer/winter' switch was referring to, but additional information has now been added by the architects. The Centre does not have a dedicated maintenance team or manager, therefore it becomes important to have labelled switches clearly explaining what such switches do.



Figure 3-3 Ventilation unit – summer/winter strategy switch (plant room)

The CO₂ sensors in the main hall and the dining area, and the presence sensors in the offices, allow for boost ventilation during the winter mode by opening up supply air valves nearby. The CO₂ sensor in the main hall is located next to the heating controls.

The CO₂ sensor in the dining room was located incorrectly. It is located immediately adjacent to the fresh air inlets that it controls. This means that when the CO₂ levels trigger the opening of the fresh air valves, and in a matter of seconds the CO₂ is washed away from the CO₂ sensor (before the general room levels of CO₂ have been lowered) and the sensor then closes the supply valve. But within seconds the high ambient levels

of CO₂ again trigger the CO₂ sensor and open the valve again. Thus the valve opens and closes at short intervals. To correct this fault, the CO₂ sensor should be moved some distance from the fresh air supply valves.



Figure 3-4 CO₂ sensor (main hall)

There is a programmable time control unit in the plant room. The running time for the ventilation unit had initially been set to 7am-7pm, and subsequently extended to 9pm daily:



Figure 3-5 Ventilation timer control unit (plant room)

After Justin Bere noticed that there are occasional events booked in the main hall which can run until late hours in the evening, Bere Architects installed a ventilation timer to extend the hours of operation. This is located at the bottom of the main staircase. This enables the centre managers to extend the running time of the ventilation by 30', 1h, 1h ½, 2h, 2h ½ or 3h, for events running after 9pm.



Figure 3-6 Ventilation extension timer (basement, main staircase hall)

The design team have deliberately put user-orientated controls (the thermostat and the ventilation boost button) outside the plant room to make them easy to access. However it has been agreed with the centre manager to put the thermostat in a non-accessible perspex box so that adjustments are only made by management, and users cannot make their own adjustments, since incorrect user settings adjustments have caused a few problems from time to time. The Perspex box is currently on order at the time of writing.

3.1.2 Summer bypass

The ventilation unit automatically controls the opening/closing of its heat recovery bypass damper. This function is delivered completely wired and motorised from the factory, according to these default settings (which were not changed by the design team):

- Opening of 100% by-pass if all of the following conditions are met:
 - a) Outside T° (sensor T1) < inside T° (sensor T2) – 1°C.
 - b) Outside T° (sensor T1) > 15°C
 - c) Inside T° (sensor T2) > 22°C.

- Closing of 100% by-pass if one of the following conditions is met:
 - a) Outside T° (sensor T1) > inside T° (sensor T2).
 - b) Outside T° (sensor T1) < 14°C
 - c) Inside T° (sensor T2) < 20°C.

This is independent of the summer/winter switch, meaning the bypass may be activated at any time when the outside temperature is above 15C.

3.1.3 Frost protection

The ventilation unit is supplied as standard with a built-in frost protection protocol for the heat exchanger, but this is automatically de-activated when the optional electric pre-heater is installed in the unit. The 6kW frost protection pre-heater is installed behind the intake filter inside the unit and is sub-metered separately. The metered electricity consumption of the frost protection pre-heater has been negligible (zero during the most recent, mild, winter).

3.1.4 Kitchen cooker hood with heat recovery

The extractor hood in the kitchen is a special extract unit with re-circulation (and therefore heat recovery) in winter conditions, and exhaust in summer. The intake and exhaust valves seal closed when not in use in order to maintain the air-tightness of the building. The installation of the extraction hood was not completed by the contractor due to a general funding shortfall that resulted in a minor dispute between employer and contractor so the design team contacted the German manufacturer in order to be able to explain to an independent electrician (post contract) how to wire up and operate the unit.



Figure 3-7 Kitchen hood, filter and controls display

3.2 Ground source heat pump



Figure 3-8 Ground source heat pump (GSHP)

The building uses a Viessmann ground source heat pump, with the specification below:

Vitocal 200 7.7 kW, BWP108
Ground circuit accessory kit
Ground circuit pressure switch
Connection set heating circuit via flexis
In-line electric heater 9kW
Heating circuit pump Grundfos UPS25-60
Tank: Vitocell 100-E (Type SVW) 200 litre
Cylinder temperature sensor
Ground manifold (PE32 x 2.9 x 4 loop)

Figure 3-9 Ground source heat pump (GSHP) specification

3.2.1 Installation issues

The initial design for a ground-source heat pump looked favourable given the very low heat demand of the building and the size of the garden for the ground loop. However more detailed investigation showed that the soil was worse in terms of heat transfer than originally thought, so considerably more pipework would be needed to meet the heat load.

There was some debate between the heat pump supplier and the installers as to what was the best solution. Boreholes would have been easier to accommodate physically but are generally considered more costly than trench solutions, so boreholes were omitted from the cost plan when a trench solution looked straightforward.

However, timing of the excavations was difficult as a clear site was needed to make best use of the area available, and the site was restricted and contained site offices.

There were additional costs in using over-sized radiators. Underfloor heating would be preferable from an efficiency point of view because it works well with low temperature water, but was not possible because of costs. In the plant room complexities were introduced as Viessmann insisted on a buffer vessel, rather than running the heating as a single zone. This is probably the better solution technically, but added to cost and required additional space in a small plant room.



Figure 3-11 GSHP control display

The domestic hot water cylinder supplied by Viessmann was a standard solar twin coil cylinder that lacked a large enough coil for a heat pump, so an additional plate heat exchanger and pump needed to be added.

Installing the GSHP system wasn't as easy as installing a gas boiler. The plumber lacked suitable training or experience in this new technology. He was confused by the equipment that was supplied and he relied on Viessmann technical support to help him identify the components.



Figure 3-10 Thermostat and DHW & heating controls (main hall)

The heat pump required was of a small capacity. However it works best on a three-phase supply which was available and beneficially enables the load to be spread equally across the phases. The installation electrician didn't realise that two separate supplies were needed, one for the compressor and one for the boost heater, plus a single phase supply for controls. This was resolved with some untidy grouping of circuits on the distribution boards. The grouping later proved to be a problem for the sub-metering layout which was finished after the main contractor had left site. Without the watchful eyes of the design team it is unlikely that the mechanical or electrical installations would have worked properly.

The GSHP is connected to a room-based control panel and thermostat in the main hall. This unit contains similar functions to a domestic boiler controller. The main functions are:

- DHW only
- DHW and Rads
- Room set temperature

As previously mentioned it has been agreed to contain this in a ventilated Perspex enclosure to avoid the risk of users tampering with the settings.

The ground-source heat pump also has its own integral control panel. This is not easily accessible and is not something that the community centre staff would normally need to access.

3.2.2 Direct heater

The GSHP was found to be using a small amount of energy overall, and the direct electric sterilisation meter showed zero consumption. An independent advisor on the monitoring team said he thought that the meter showing zero was probably broken and that the building might in fact be using a lot of unmeasured direct electricity on this circuit. However when this hypothesis was investigated in May 2013, it was found that the meter was working and the reason it showed zero was that the direct electric sterilisation circuit was not connected up to make it operational.

When connected up, the direct electric heater is 9 kW, spread over three elements, which can each be enabled so as to provide 3, 6 or 9 kW depending on what is required to take the water storage up to 60°C once a week. The team found that the immersion heater power connection plug was still coiled in the manufacturer's cable tie (image below). As well as providing protection against Legionella bacteria through a once-weekly sterilisation of the domestic hot water, the immersion heater can also support space heating in winter if the heat pump is unable to meet the heat demand.

Since the direct electric heater had not been connected to power inside the GSHP, the space heating and DHW had been, until May 2013, provided solely by the compressor of the GSHP without any contribution from the immersion heater.



Figure 3-12 The GSHP direct heater as found in May 2013 (left), and after it was connected (right)

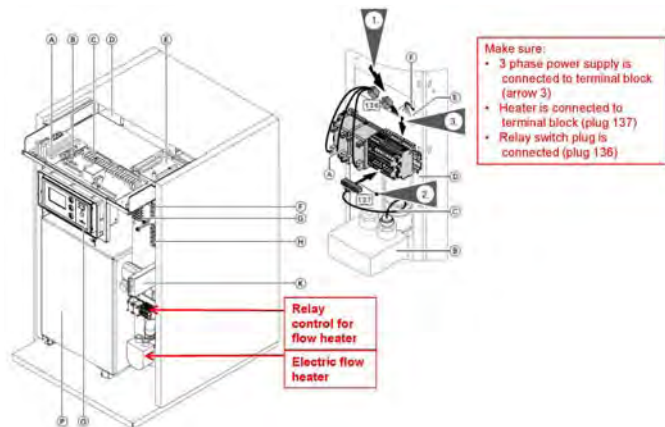

Figure 3-13 Schematic sent by Viessmann technical to show connection of GSHP direct heater

3.3 Photovoltaics array



Figure 3-14 Mildmay Centre - photovoltaics arrays (on the main zinc roof and on the ground floor extension)

The photovoltaics panels system details are as follows:

Module Manufacturer: Sharp
Module Model: 77 x NU-E235E1
Total Module Area: 77 x 1640 x 994mm m2
Peak Power Output: 18 kWp
Grid Connected
Inverter Manufacturer SMA
Inverter Model 6000 TL
Estimated Annual Energy Yield 14476 kWh

Figure 3-15 Mildmay Centre – photovoltaic system details

As illustrated further in ‘Chapter 6 Energy Use’, the PV array generated approximately 13600kWh of electricity between August 2012 and July 2013, and 14400kWh between August 2013 and July 2014. This is very close to the estimated energy yield for the panels. The annual energy generated by the PV array amounted to between 17 and 18kWh/m2.year.

Not all the electricity generated by the PV panels will be used by the building. The actual amount used is calculated by subtracting the energy exported back to the grid from the total electricity generated by the panels.

However the team found that the sub meter labelled ‘PV export’ was actually recording PV generation. The issues encountered with the sub-metering of the electricity generated and exported are described in more detail in Chapter 5.2 Metering strategy and issues.

3.4 Solar thermal panel

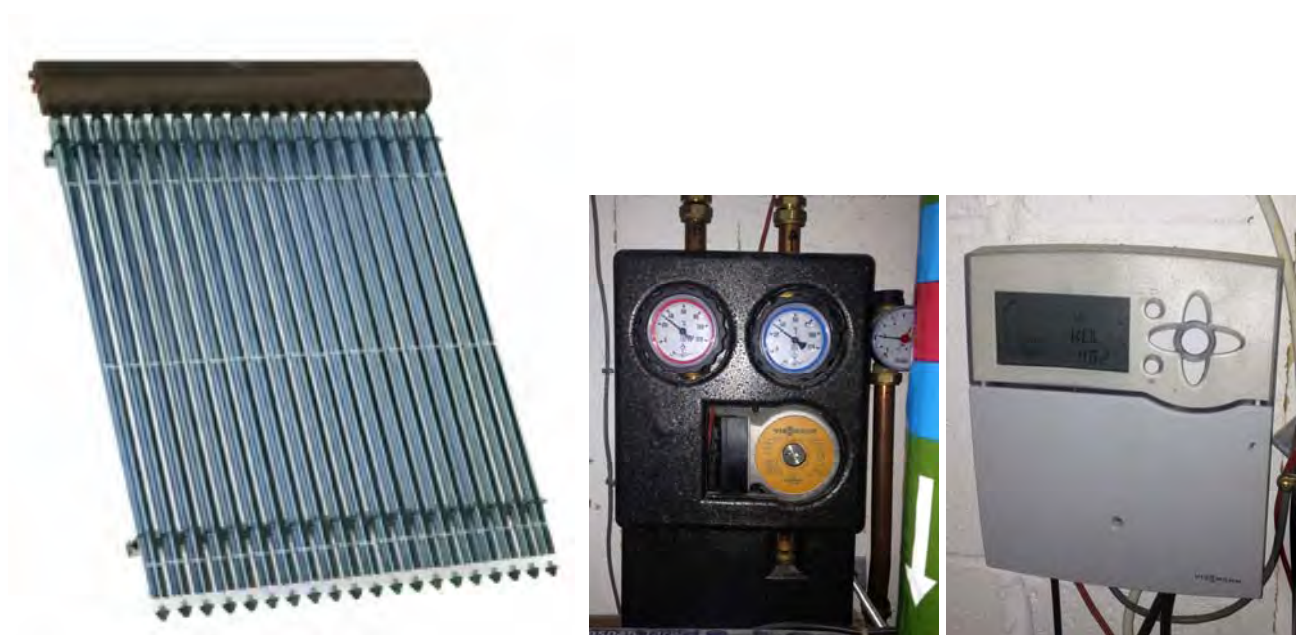

Figure 3-16 Solar thermal panel, pump and control display

The estimated annual energy yield of the solar thermal panel is 1241 kWh/year. The Passive House Planning Package (PHPP) estimated that the solar thermal contribution to the domestic hot water load would be approximately 30%. The team did not note any problems with the system, and although the solar thermal production was not monitored, the team regularly checked the temperatures on the solar pump flow and return. The panel is connected to a Vitocel 300b cylinder (300litres) with twin internal coil.

The 3m² panel is a Vitosol 200t vacuum tube collector with the following characteristics:

Solar collector type	Vitosol 200t sp2
Quantity	1 bank of 30 tubes (3m2)
Roof kit type	Pitch / surface mounted
Pump unit(s)	Solar 25/60/130
Expansion vessel capacity	25 litre, reflex s
Intermediate vessel capacity	None
Control unit	Vitosolic 100 sd1
Heating medium	Tyfocor
Cylinder(s)	Vitocell 300b 300 litre twin coil evb
Unvented	Yes

Figure 3-17 Solar thermal system details

3.5 Lighting

3.5.1 Commissioning, wiring and controls

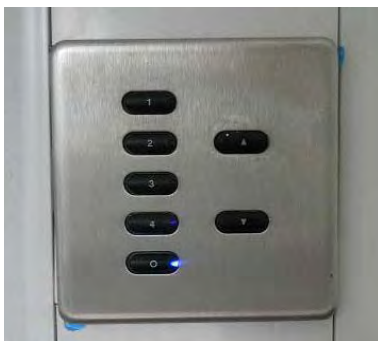

Figure 3-18 Light switches with controls for dimming or selecting pre-set light levels

As part of a cost reduction exercise some of the proposed dimmable lights were replaced by non-dimmable fixtures in office spaces. This affected the commissioning of the lights and where lights are non-dimmable, the installed light switches (remote dimmers with five programmable lighting scenes) are more complicated than they need to have been. There were also a number of additional problems related to wiring and commissioning.

The lighting for the ground floor offices and first floor meeting rooms is almost entirely fluorescent, and is controlled by a 'Coopers iLight' controls system. This was specified by the lighting designers to provide dimming functions and daylight linking through the software, with push-button switches located on surface-mounted cable trunking.

Budget restrictions led to some of the lighting system being reduced to simple on-off controls, with manual on and manual off switching, with automatic off switching occurring if the lights are left on in an unoccupied room. However, the savings were not made until after the multi-function light switches (the iLight standard offering) had already been installed, even though a standard on/off switch would have sufficed in these areas. This has led to occupants becoming slightly confused as to what the buttons do. Further confusion was initially caused by poor programming and incorrect wiring, resulting in lights turning off by themselves when lighting was needed. Re-commissioning, which the manufacturer wanted payment for, eventually fixed most of these problems.

The Coopers switches with dimming capability have no labelling to identify what the buttons do. The lighting (lux) levels were intended to be easily modified according to users' preferences. However, iLight use a closed communications protocol devised in-house called ICAN. This means only someone with the right software interface can access the system and make changes.

For about £300, iLight provide ICAN Soft, a technical interface module that runs on a PC and can be used, with a bit of training, to modify lighting controls settings. Mildmay Community Partnership has neither the software, the cabling, nor the skills to do this. This means there is an on-going dependency on iLight, who charge a high price for their time and expertise to make any changes to the pre-set lighting levels.

The experience of this project has led the design team to make it a company policy to ensure that lighting designers in future avoid closed communications protocols for cost reasons and due to the risk of obsolescence.

There was also a fault in the wiring: the kitchen lights switch was not reliable, and eventually could not be switched off except if the Centre managers switched lights off at the circuit breaker located in the iLight panel in the basement plant room. The result was that the lights were left on 24/7 until this problem was fixed by an independent electrician in August 2014.

The problem was caused by incorrect routing of a control wire to the outside face of the building where moisture ingress caused interference. The iLight system is controlled by a single multi-core control wire that loops around a substantial number of fittings to be controlled. This control cable is susceptible to water ingress at any connections which could upset the controls function of any lights on the circuit. Where external PIR sensors were fitted, the controls cable incorrectly looped to the outside of the building. If the PIR sensors had been wired correctly, the main control cable would have remained inside, free of water penetration and a spur would have passed outside to each of the PIR sensors. Since in this installation the cable looped outside, when water penetrated the PIR sensors, this upset the controls system and this manifested itself by affecting the control of the kitchen lighting.

The architect was disappointed to learn that the wiring has not been corrected, simply that the PIR sensors have been sealed with silicone. This means that there is a high risk that the lighting controls on the ground floor of the building will fail again at some point in the future.

3.6 Conclusions and key findings for this section

The main conclusions and findings for this section are:

1. It should be remembered that the purpose of a ventilation system is to 'ventilate the users', rather than ventilate the building itself. For this reason, since this non-domestic building is unoccupied at night, a programmable timer was provided in order to ensure that the ventilation system does not waste energy by running outside hours of occupancy. A run-on switch was retrofitted to provide ventilation where required outside normal hours of occupation, such as for a party.
2. A lesson learned: twice-yearly operation of the winter/summer ventilation strategy switch located in the plant room is very easily overlooked by the Centre management team. An automatic calendar switch would be better; or alternatively the switch could be left on winter setting without a large impact on the overall energy use of the building.
3. Thermostat controls may be best placed in a tamper-proof enclosure.
4. The problems encountered around the wiring of the special control unit of the kitchen hood pointed to the fact that English language manuals are important for imported products.
5. The direct-electric heater had not been connected to power at the installation of the GSHP, which meant that the weekly disinfection of the system did not occur over the first winter. This is an example of the wide range of potential issues arising when mechanical and electrical systems are not properly installed and commissioned by the contractor.
6. The 3-phase connection for the GSHP was overlooked by the contractor. While this was corrected post-contract, the wiring layout was problematic with regards to the sub-metering.
7. The wiring, programming and controls of the lighting system need to be kept as simple as possible, and European open-source protocols are likely to be easier and cheaper to maintain than closed protocol systems. Keeping control wires dry is important in order to avoid malfunction in the control system.
8. Well installed and commissioned systems (such as the heat recovery ventilation and the PV panels) were found to work reliably and as planned.
9. An important conclusion drawn by the design team is that it would be very helpful for the mandatory sub-metering of circuits to be independently checked on site prior to completion by an independent electrician or other qualified professional, so as to check that the sub-metering strategy and the respective systems are working as intended, and are fully operational. It seems from speaking with other people, that the quality of this work is often sub-standard, so a third party certificate and on-site demonstration of compliance could be a Building Control requirement.

4 Key findings from occupant surveys

4.1 Interviews with site manager, sub-contractor, MCP managers and board member

Over the course of the BPE study several interviews were conducted with the main parties involved in the project.

Roderic Bunn, the BSRIA independent consultant who advised the design team during this BPE project, interviewed the clients (the Centre managers), the electrical sub-contractor and the main contractor's site manager. (see appendices 14 &15)

The design team interviewed one of the initial instigators of the refurbishment project, a Mildmay Community Partnership board member who is also actively involved in several activities around the Centre, and they also interviewed the Centre Manager (appendices 13 & 20).

4.1.1 Telephone interview with the Main Contractor's Senior Site Manager- summary (full transcript in Appendix 10.14).

The main contractor's site manager had no previous experience with Passive house, but did a lot of background research and was determined to get certification (b:a note: the building achieved certification). Their earliest recollections of the project are of meetings with the residents and local community to discuss the project plan and disruptions involved by the construction works.



Figure 4-1 Window airtightness taping – training on site

The construction team was not familiar with typical passive house construction elements, such as airtightness membrane, specific seals and tapes. (b:a note: comprehensive pre-construction air tightness training of the site manager and other key staff was included in the contract, and paid for by the employer). Working with airtightness products during the winter was difficult, and the programme was slightly delayed.

The induction process on site was 20min longer than usual, 'everyone had a role to make the Passive House work'. People left site feeling they had learned a lot. There were some issues with external insulation glued to the building to ensure no air movement. The GSHP was a late addition (b:a note: through a grant), so room was needed to be made in order to excavate for the ground loops.

The Site manager felt the major lesson learned on the project was the training. One thing to be done better in the future: pricing, planning and scheduling of works on site.

4.1.2 Interview with the Electrical sub-contractor, conducted by Roderic Bunn (BSRIA)-summary (full transcript in Appendix 10.14)

In the electrical sub-contractor's view, the problem with the project was the lack of funding, which in turn meant that the specification was reduced constantly, and the basement and kitchen fit out was taken out.

The 5 channel light switches were wired on and off, and with presence detectors auto-off. The dimming function was taken out as well, to save money, except for the main hall, dining and kitchen. Some areas had a daylight and PIR control, but in the dining area the lux level control was disabled to an on and off switch.

'The building is set up and wired for user-controlled dimming. There is capability for the five controls channels via the wall switches and the wiring is installed, but the controls hardware is not installed, to save money.'

The lighting system can only be re-commissioned every time by iLight who need to come to site with a computer.

The PV export meter was not installed, a bi-directional sub meter installed in the main distribution board panel.

An extra, unexpected electricity supply was needed by Viessmann for the GSHP. Design team note: the direct heater (3rd circuit) was not connected in the GSHP, or metered.

The initial sub-metering strategy was dropped due to lack of funding, but Part L sub-metering was installed.

The electrical sub-contractor would have preferred a BMS control system. (Bere Architect's note: It was a fundamental of the M&E design strategy to avoid the need for a BMS system in order to keep the controls as simple as possible and as easily maintained as possible.) (Full transcript in appendix 10.14)

4.1.3 Interview with the Centre's management, conducted by Roderic Bunn (BSRIA)-summary (full transcript in Appendix 10.15)



Figure 4-2 The Mayville/Mildmay Community Centre managers in an interview in 2012

The Centre managers felt they got more than expected out of the project, and that (at the time of the interview, Spring 2012, soon after re-opening the Centre) they found many of the features of the building

puzzling, such as: the pipework, the ventilation outlets and strategy, how the solar panel, or heat distribution, work.

They found the controls located in the main hall '*absolutely fine*' and a perfect temperature inside, '*neither too hot not too cold*'.

The Centre's managers felt at the time of the first interview that information points were needed to explain what each switch does (note: b:a subsequently installed small information boards throughout the building).

Things they thought could be done differently: simpler light switches, reception staff desk separated by window/screen (b:a note: glass enclosure was included in original design but omitted due to lack of funds).

'The old building seemed really dark and dingy, and now it's great, it's bright and airy', and as the building has more to offer, there's a little bit of pride creeping in'

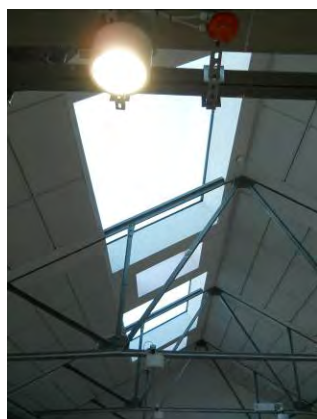

Figure 4-3 Rooflights in the main hall

Other things that the managers thought could be added: blinds across the skylights to block sunlight for presentations; also, at times the sound from the main hall can be heard in reception area due to open staircase well and landing area on 1st floor open towards the main hall.

Answering a question about the number of toilets in the Centre, the managers replied it was a matter of perception, as people thought they would have more toilets than before the retrofit. Light switches in toilets: now on presence detectors, but for children or elderly may be better with manual switch and a timer. (b:a note: everyone appears to have got used to the automatic switches in the toilets by the end of the monitoring period and nobody comments on this anymore).

One tenant using a south side office required privacy, therefore a balance had to be struck between solar gains for heating versus privacy. The compromise was clear glass to let the sun in, and solar control. (b:a note: external blinds can be tilted upwards to allow heat in while maintaining privacy).

As a conclusion, *"The unanimous response is that it's a lovely building and that it's really comfortable, and that's from people who use it as a conference and meeting place"* (Full transcript in appendix 10.15)

4.1.4 Interview with a Mildmay Community Partnership board member (full transcript in appendix 10.13)

This board member was in 2006 one of the main instigators of the project to refurbish the Mayville Community Centre . She was also one of just two board members who remained a board member after the refurbished centre re-opened. More than two years after the completion of the building, with monitoring results showing its energy and comfort performance, Bere:architects asked this key MCP board member to answer some questions on how the project came about, the construction process and comments and feedback on whether she is satisfied with the outcome.

A broad range of topics was discussed:

1. What were your hopes for the project and how do you feel it has turned out?

All aspirations appear to have been met and the interviewee was very pleased with all aspects of the resulting building, including its appearance, comfort and performance.

2. How do you feel about the Passivhaus approach to the project?

The interviewee referred to the perception that there was some risk in the project, especially from the MCP Board at the time, and that she felt it's importance as a pilot project was recognised by the Carbon Trust but not sufficiently by other potential funders.

3. Why did you choose/support bere:architects?

The interviewee expressed satisfaction with the reciprocal support and effort provided by the architects.

4. What do you feel were the major challenges to completing the project?

The interviewee mentioned several:

- The gardens had to be re-designated by the council as being part of the leasehold and belonging to the community centre rather than as had been the case, enclosed and unused but nominally attached to two of the housing stocks abutting the community centre and gardens.
- The interviewee mentioned the controversy surrounding a council tree officer's requirements regarding a small tree that obstructed progress, despite the careful saving by the design team of a larger tree. The interviewee mentioned the difficulties experienced in keeping local residents informed and in support.
- The interviewee referred to funding as a key issue.

5. Was the project a success in your view? What is your opinion now that is built and running?

- The interviewee referred to:
- " a stunning, elegant building... extended useable space by at least 30%; incorporated the garden; light and external space in totally draft free rooms; has an amazing 'feel' to the building in relation to air quality, ambient temperature in Winter and Summer..."
- "We have a very much reduced energy bill, and when we sort out computing/server issues totally unrelated to the retrofit, we will I am sure approach less than a quarter the consumption we have currently."

6. What do you think could have been done better?

"In relation to the retrofit, nothing"

7. What impact do you think the building has so far had on the community?

"Much of what was done to the community centre showed how local stock might be retrofitted and attend to thermal bridges, improve/remove drafts, increase knowledge and use of land for growing food."

8. Do you think that the building has a wider educational role to play? If yes, how could this be achieved?

"Yes it does, and this has already begun as we participate in Open House weekend, a London wide event allowing people to look round. We have been the venue of choice for National conferences on wildlife gardening and eco- friendly developments. The architects have been proactive in hosting national and international events within the centre, and the centre was awarded first prize Passivhaus retrofit. We have

hosted people's science events to help in the understanding of CO2 emissions and reduction, been the centre of choice with links to MSc studies with UCL, held numerous events on energy reduction, been part of national monitoring scheme on energy consumption, shown how easy incorporation of wildlife habitats can be into the fabric of a building, influenced the upgrading of housing stock to be more carbon neutral. This work is continuing and becoming more critical in a world where extreme weather events threaten increasingly, the human now as well as wildlife habitats."

9. How can the lessons learned from this project inform other projects, specially other community centres?

"We act as an educational hub for communities in Islington. People that come along can compare us with their usual community centre, and we are always favourably regarded. We have very strong links to schools, universities and national conferences..."

10. What do you think of the savings the retrofit has brought to the building? What is your opinion on the environmental performance

"This is self-evident from fuel bills."

11. How could more retrofits of this kind be encouraged?

Several ideas can be found in the full transcript

12. Any other thoughts that you would like to pass on to architects, engineers or policy makers?

Several ideas can be found in the full transcript. . (Full transcript in appendix 10.13)

4.1.5 Second interview with the new Centre Manager at the end of the monitoring period (full transcript in appendix 10.20)

At the time of the first interview, (See appendix 10.13), there was a Centre Manager and an Assistant Centre Manager. The Centre Manager had led the project from the start, negotiating the numerous political obstacles. But after completion he left MCP and the Assistant Centre Manager was subsequently appointed as Manager.

The new Centre Manager was interviewed towards the end of the monitoring period. She said that she had expected the building to have bigger impact locally, and felt that her organisation hadn't taken full advantage of the uniqueness of the building or explained its purpose to the community. She also expressed the concern that people didn't know about the performance of the building, although she did not suggest how this could be communicated more strongly than it is already by user dissemination meetings and posters. (Full transcript in appendix 10.20)

4.2 BUS methodology studies

During the BPE study phase 2, an official Building User Survey (BUS) was undertaken to assess the occupants' perspective of the building in operation. The BUS methodology is a standard survey procedure developed by Building Use Studies Ltd., Bill Bordass and Adrian Leaman.

A BUS survey delivers a detailed diagnosis of human needs in buildings, using a generic and adaptable questionnaire which looks at perceived comfort, use of space, control options and productivity and various other factors. The results are compared against a UK benchmark (the reference dataset for non-domestic benchmarking is made up of around 66 projects). (ref www.busmethodology.org.uk). the BUS variables and indices provide an overview of the building's performance.

For each variable the absolute results are averaged and the score is compared to the benchmark reference. Each variable score can be visualized in a slider graph. The BUS analysis compares each variable average score with two references. One is the benchmark critical region (determined by the benchmark mean and upper and lower limits) and the other the scale mid region (determined by the scale mean and upper and lower limits).

Depending on the relative position to these two references the scores are coded with colours.

AMBER – Means the score falls in the benchmark critical and scale mid regions.

GREEN – Means the score is considerably better than the benchmark and depending on the type of question (A, B or C) is close or distant from the scale midpoint

RED – Means the score is considerably worse than the benchmark and falls out of the benchmark critical and scale mid regions.

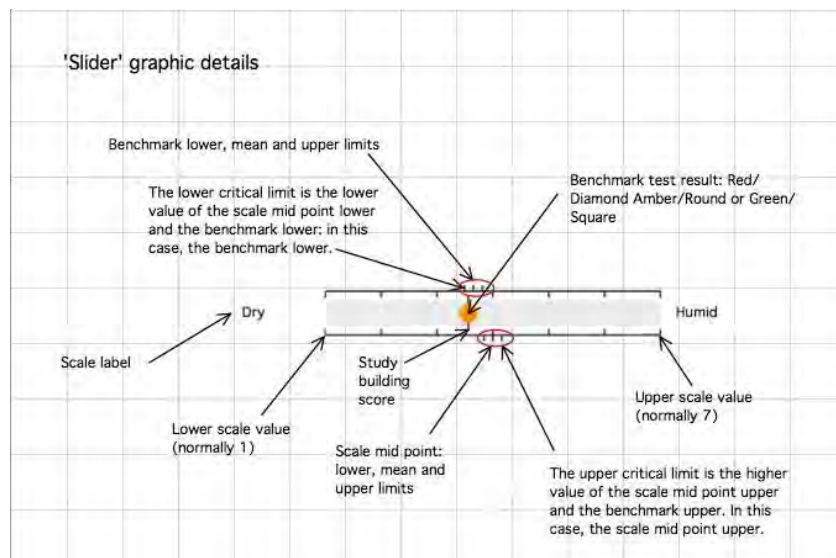

Figure 4-4 BUS variables slider – graphic explanation (Source: Usable Building Trust)

The design team moved into the basement office in the Centre in August 2012. In order to preserve the independence of the study, the building user survey was carried out by the TSB evaluator rather than the project lead. It is true that, as professionals who understand how the building works, and interested in the way their own design is performing, the tenants in the basement might be more enthusiastic in their opinions about how the Centre performs. However, the architects' office accounts for only approx. 25-30% of the total number of the permanent occupants, but 32% of all replies were from the architects's office in the 2013 BUS survey and 47% of all replies were from the architects's office in the 2014 BUS.

The first survey was undertaken in the summer of 2013, with disputed results (See section 4.2.2). The design team's view was that the BUS methodology survey performed in the summer 2013 was not representative of

a working building, since the summer ventilation strategy was not operational as the rain sensors on the main hall rooflights had not been connected by the main contractor due to a financial dispute with the clients. As a result, the Centre managers were reluctant to use the rooflights for purge ventilation, for fear the rain might damage the hall. As such, the building was not fully operational as intended during design. It was however agreed with the Technology Strategy Board that a new permanent user survey would be carried out during the next summer, in 2014, when the building was expected to be fully operational, and that both results would be examined and presented in this final report. Furthermore, since the building is a combination of office accommodation and community centre, the majority of users are transient and were not included in the permanent survey. It was therefore agreed that a transient BUS methodology survey was desirable as these users experience the building in a very different manner and that it should also be carried out in 2014.

The following sub-chapters present the three BUS methodology survey results. The study carried out in the summer of 2014 (when the rainsensors on the main hall rooflights were operational) is presented first as the results are considered representative of a fully working building. This is followed by the 2013 survey results with a comparison between the two studies. The transient occupants' survey carried out in the summer of 2014 concludes this chapter.

The links to the Mildmay occupants' surveys and a brief explanation of the visual references and indices used are attached to this report in Appendix 10.10.

4.2.1 Surveys results – permanent occupants of the building – Summer 2014

The survey was carried out in July 2014 by the TSB evaluator to ensure that the BUS study is administered in an impartial and independent manner, since the architects are tenants in the building themselves.

The surveys were hand delivered to all present occupants in all offices and collected a couple of hours later. The survey had 16 respondents, 68% of which have been working in the building for one year or more. The following is a summary of the results, the complete anonymous data tables can be found through the following link: <http://portal.busmethodology.org.uk/Upload/Analysis/1vhk23s3.tps/index.html>

4.2.1.1 Summary indices

Table 4-1 indicates that the Mildmay Community Centre has very positive levels of performance on the Comfort, Satisfaction and Summary indices. The mean values are above average and by comparison with the benchmark database, the building is rated in the mid-high percentiles.

The Forgiveness index is a measure of the users' tolerance of the building environmental performance and takes into consideration the results of the 'overall variables' of the study as detailed further below. The rating for the Mildmay Centre is slightly above the average, indicating that the occupants feel fairly comfortable and are willing to overlook some of their complaints on the building performance. For an explanation on the indices calculation please see Appendix 10.10.

Table 4-1. 2014 Survey - BUS methodology Indices

	Mean	Percentile	Scale
Summary	0.42	74	[-3 to +3]
Comfort	0.41	74	[-3 to +3]
Satisfaction	0.43	73	[-3 to +3]
Forgiveness	1.08	51	[-0.5 to +1.5]

4.2.1.2 Overall results

Table 4-2 shows the results for the overall variables. In general, the Mildmay Centre occupants are quite satisfied with the building overall comfort conditions and cleaning levels and feel healthier when they are in the building – one comment noted the quality of the air “[...] when in long meetings here no lethargy – at other centres smelly stuff and 3pm is a time to sleep”, others valued the fresh air and the location away from busy roads. Some respondents noted that despite the overall comfortable conditions the building “can overheat on really hot days”.

Regarding other variables, the building results are higher than average. The occupants appear to be fairly satisfied with the building design and image to visitors, as well as with the use of the space and personal safety in and around the building.

Table 4-2. 2014 Survey - Overall variables

Variable	Result	Mean	Percentile
Comfort: overall		5.06	64
Health (perceived)		4.81	95
Design		4.93	36
Needs		4.8	29
Space		4.93	39
Image to visitors		5.06	21
Safety		5.93	47
Cleaning		6.18	85

4.2.1.3 Work conditions

The survey also included several questions to assess the Mildmay Centre as a working space (Table 4-3). The majority of the occupants responded positively to whether the facilities met their needs. As things that hinder effective working, several comments referred to noise as a nuisance, namely the distracting effect of the noise levels from the different functions organised in the Centre. Regarding the things that work well,

occupants mostly refer the good levels of natural light, comfortable temperatures and good ventilation levels, as well as the connection with the silent surroundings.

The work conditions results show the differences between several offices, as each tenant was responsible for the furnishing of their own office. In general occupants are satisfied with the usability of the furniture provided but less so with the allocated space at their desks. Although in the building context this result is close to average, when comparing with the benchmark it falls in percentile 6, meaning it's one of the buildings with less people content with the space at their desks. This might be explained by the fact that most of the rooms used now as rented offices (and adding to the Centre's income), had initially been intended for, and designed as, temporary meeting and workshop rooms.

Finally results from the perceived productivity show that more than half of the respondents believe their productivity is increased by the environmental conditions in the building. Respondents' comments noted the fresh air quality as a positive aspect and heat and noise as hindering aspects.

Table 4-3. 2014 Survey - Work variables

Variable	Result	Mean	Percentile
Works needs		4.87	19
Work furniture		5.37	60
Desk space		3.56	6
Productivity		0	56

4.2.1.4 Environmental Comfort

To describe the thermal comfort of the building, several variables are assessed: temperature in summer and winter (Table 4-4 and Table 4-5) and air quality in summer and winter (Table 4-7 and Table 4-6). Overall temperatures in winter and summer are seen as comfortable and, by comparison with the benchmark, the Mildmay Centre's performance is very positive. Winter temperatures are perceived to be slightly cold and stable throughout the day and in summer slightly warm with more variation throughout the day.

Table 4-4. 2014 Survey - Temperature variables in winter

Variable	Result	Mean	Percentile
Temperature in winter: overall		4.86	79

Table 4-5. 2014 Survey - Temperature variables in summer

Variable	Result	Mean	Percentile
Temperature in summer: overall		4.5	70

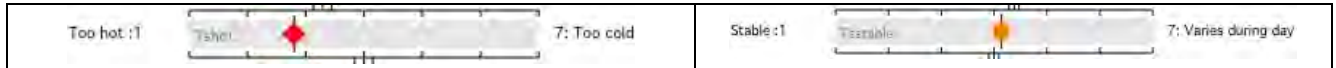

The overall air quality is perceived as satisfactory both in winter and summer, and the results compare positively with the benchmark, with the Mildmay Centre performance to be above average (slightly better in winter). Results are very similar in both winter and summer, showing a very stable performance throughout the year. Air was noted as odourless, fresh and slightly still and dry.

Table 4-6. 2014 Survey - Winter air quality variables

Variable	Result	Mean	Percentile
Air in winter: overall	Unsatisfactory :1 7: Satisfactory	4.73	73
Still :1	Draughty	Fresh :1	7: Stuffy
Dry :1	Humid	Odourless :1	7: Smelly



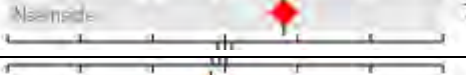

Table 4-7. 2014 Survey - Summer air quality variables

Variable	Result	Mean	Percentile
Air in summer: overall	Unsatisfactory :1 7: Satisfactory	4.31	60
Still :1	Draughty	Fresh :1	7: Stuffy
Dry :1	Humid	Odourless :1	7: Smelly

4.2.1.5 Noise conditions

As mentioned earlier, the internal noise transference rank at the top of the complaints from the building's regular users (while the building is considered very well protected from external noises) but the overall building's performance regarding noise is mildly satisfactory (see Table 4-8 for the results from the different noise variables that were assessed). The noise transference is more due to the nature of the building use than to construction problems. The building is a community centre which hosts a wide range of activities with very different noise levels. The main hall is regularly rented out for very different functions, some noisier than others. The first floor offices have little physical separation with this space and eventually suffer from noise disturbance. Also the reception area where the Centre management team works has no separation with the entrance lobby, leaving them more exposed to noise and unwanted interruptions (it should be noted that the design project included a glass separation that was never installed due to the lack of funding). Moreover, all offices are shared spaces with between 2 and 8 people.



Table 4-8. 2014 Survey - Noise variables

Variable	Result	Mean	Percentile
Noise: overall	Unsatisfactory :1  7: Satisfactory	4.31	45
Noise from colleagues	Too little :1  7: Too much	4.37	58
Noise from other people	Too little :1  7: Too much	4.93	89
Other inside noise	Too little :1  7: Too much	4.81	92
Noise from outside	Too little :1  7: Too much	3.8	42
Unwanted interruptions	Not at all :1  7: Very frequently	3.93	40

4.2.1.6 Lighting conditions

On the other hand the lighting conditions are perceived to be satisfactory, with good levels of natural and artificial light. Some glare from sun and sky was noted, but almost none from artificial lights. 68% of the respondents seat next to a window.

Table 4-9. 2014 Survey - Lighting variables

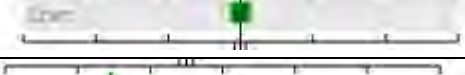
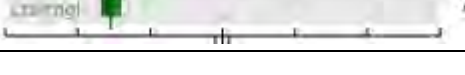
Variable	Result	Mean	Percentile
Lighting: overall	Unsatisfactory :1  7: Satisfactory	5.25	70
Natural light	Too little :1  7: Too much	4.33	89
Glare from sun and sky	None :1  7: Too much	3.2	22
Artificial light	Too little :1  7: Too much	4	19
Glare from lights	None :1  7: Too much	2.46	5

4.2.1.7 Other variables and conclusion

Regarding the building management, 56% of the respondents have never made a request to change anything in the building. From the ones who did, the satisfaction with the speed and effectiveness of the response varied on a wide scale, from very unsatisfied to very satisfied. 66% of the respondents said they do not change their behaviour because of the building conditions. Finally, regarding the means of travel to work, the majority of the building users walk, this is followed by the use of bicycle and train.

Overall the Mildmay Centre results were positive and compare favourably with the benchmark on many aspects. The BUS methodology survey was also able to highlight where, in the users' perspective, the

building has succeeded most and where it has fallen short. However the variety of type of users with different needs and expectations may have influenced the results.

4.2.2 Surveys results – permanent occupants of the building – Summer 2013

The previous study was carried out in July 2013 (at a time when the rain sensors were not operational and the summer ventilation strategy was not operational). The surveys were hand delivered by the TSB evaluator on this BPE project to all permanent occupants present in the building, and collected a couple of hours later,. The survey had 22 respondents, 42% of which have been working in the building for one year or more. The following is a summary of the results, the complete anonymous data tables can be found through the following link: <http://portal.busmethodology.org.uk/Upload/Analysis/l3tjum22.4pn/index.html>

It is important to note that the two surveys results are compared to different benchmarks – the 2014 study compares to the BUS benchmark 2012 while the 2013 study compares to the BUS benchmark 2011. This means that the colour/shape coding of the results is different because it relates to different benchmarks, making it more difficult to establish a comparison.

4.2.2.1 Summary indices

Table 4-10 shows the general indices results for the 2013 survey, compared with the 2014 results (for an explanation on the indices calculation please see Appendix 10.10). The Centre showed an average level of performance on the Comfort, Satisfaction and Summary indices, with the results being positioned on the middle percentiles. Compared to 2014, the results in 2013 were worse, except for the Forgiveness index.

The Forgiveness index is a measure of the users' tolerance of the building environmental performance. It is interesting to note that even though the users seemed less content with the building performance in 2013 than in 2014, in general they felt comfortable and were more willing to overlook their complaints on the building performance.

Table 4-10. BUS methodology Indices – 2013/2014 comparison

	Mean 2013	Percentile	Mean 2014	Variation	Scale
Summary	0.18	58	0.42	57%	[-3 to +3]
Comfort	0.08	53	0.41	80%	[-3 to +3]
Satisfaction	0.28	65	0.43	35%	[-3 to +3]
Forgiveness	1.16	86	1.08	- 7%	[-0.5 to +1.5]

4.2.2.2 Overall results

Table 4-11 shows a comparison of the overall variables from the surveys carried out in 2014 and 2013. In general the results were fairly similar in the two years with the exception of the temperature and air quality in summer which was rated worse in 2013, and the noise level. This will be examined in more detail further in this chapter.

Table 4-11. BUS methodology results overall variables comparison between summer 2014 (left) and summer 2013 (right)

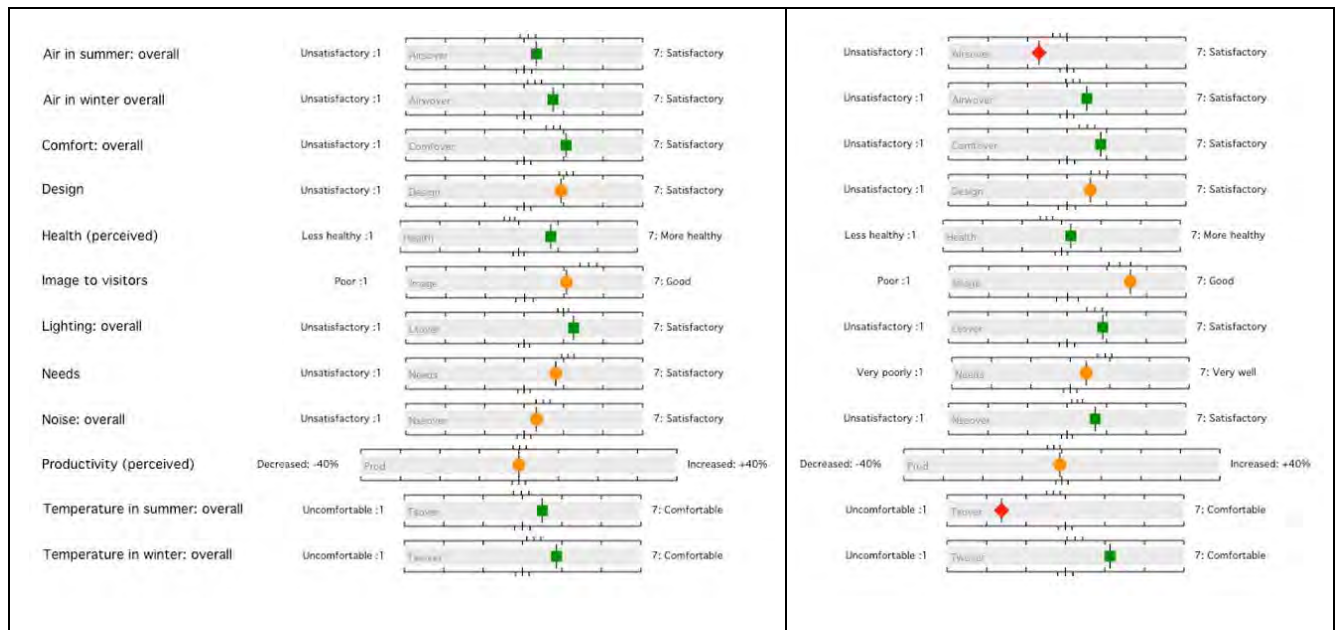

To avoid confusion the research team decided to look at the study means from both years' surveys and analyse the variations of the results from 2013 to 2014. Concerning the general and work variables, a comparison summarized below in Table 4-12, shows that the results variation is not significant but most of the ratings have in general improved in 2014.

Table 4-12. General and work results: 2013 and 2014 studies comparison

Variable	Scale	Mean 2013	Mean 2014	Variation
Comfort: overall	Unsatisfactory - Satisfactory	4.85	5.06	4.3%
Health (perceived)	Less healthy - More healthy	4.23	4.81	13.7%
Design	Unsatisfactory - Satisfactory	4.59	4.93	7.4%
Needs	Unsatisfactory - Satisfactory	4.4	4.8	9%
Space	Ineffective - Effectively	4.54	4.93	8.6%
Image to visitors	Poor - Good	5.59	5.06	-9.5%
Safety	Poor - Good	5.45	5.93	8.8%
Cleaning	Unsatisfactory - Satisfactory	6.4	6.18	-3.4%
Works needs	Very poorly - Very well	4.95	4.87	-1.6%
Work furniture	Very poor - Very good	5.15	5.37	4.3%
Desk space	Too little - Too much	4.1	3.56	-13.2%
Productivity	-40% - + 40%	-0.5	0	0.6%

In the 2013 survey, the respondents' written comments regarding the building's ability to meet the users' needs mentioned the comfortable environment but complained about the lack of sufficient toilets and the hot temperatures in the summer. Regarding the building's suitability for the users' work requirements and their productivity the respondents noted as positive aspects: the amount of natural light and the comfortable and quiet environment, as well as the external garden and the opportunity to integrate with other people. As things

that hinder effective working, the users noted the hot summer temperatures, noise disturbances from the centre activities in the main hall and reception area and also the lack of storage facilities.

4.2.2.3 Environmental comfort

The results for the environmental comfort variables summarized in Table 4-15 highlight the major differences noted between the two studies. In the 2013 the users rated the summer temperatures as too hot and uncomfortable (Table 4-13) and were also critical of the air quality variables (Table 4-14).

Table 4-13. 2013 Survey - Temperature variables in summer

Variable	Result	Percentile
Temperature in summer: overall	Uncomfortable :1 7: Comfortable	3
Too hot :1	Too hot :1 7: Too cold	
	Stable :1 7: Varies during day	

Table 4-14. 2013 Survey - Summer air quality variables

Variable	Result	Percentile
Air in summer: overall	Unsatisfactory :1 7: Satisfactory	21
Still :1	Still :1 7: Draughty	
	Fresh :1 7: Stuffy	
Dry :1	Dry :1 7: Humid	
	Odourless :1 7: Smelly	

As detailed in the chapter 5, in 2013 the temperatures were quite high, both external (it was one of the hottest summers in the UK history) and internal. Regarding the internal temperatures, the research team noted that the summer cooling strategies implemented in the building like nighttime purging and external blinds were not being used in an effective manner. The rain sensors on the main hall rooflights had not been connected during construction and the centre managers were reluctant to leave the rooflights open for fear rain could damage the hall. Also it had been determined in a workshop that the building occupants were not really aware of how to use the blinds in an effective manner or that they could use night time ventilation to cool their offices by leaving their windows on tilt.

In October 2013 the rain sensors were connected and the managers started using night purging confidently. In the following summer the design team reminded the users of the benefits of night ventilation in their offices and the use of the external blinds. The summer environmental performance results improved notably, both in the monitored temperature results (see chapter 5) as well as in the occupants' perception. It should be noted that in general 2014 had a warmer summer than 2013. The findings indicate how critical seasonal commissioning is post completion in order to ensure the building is performing as intended during design.

Table 4-15. Environmental comfort results: 2013 and 2014 studies comparison

Variable	Scale	Mean 2013	Mean 2014	Variation
Temperature in winter: overall	Uncomfortable - Comfortable	5.13	4.86	-6%
Air in winter: overall	Unsatisfactory - Satisfactory	4.5	4.73	5%
Temp Winter: Hot/Cold	Too hot - Too cold	4.71	4.71	0%
Temp Winter: Stable/Varies	Stable - Varies during the day	3.28	2.61	-26%
Temperature in summer: overall	Uncomfortable - Comfortable	2.38	4.5	47%
Air in summer: overall	Unsatisfactory - Satisfactory	3.29	4.31	24%
Temp Summer: Hot/Cold	Too hot - Too cold	1.93	2.8	31%
Temp Summer: Stable/Varies	Stable - Varies during the day	3.23	4.14	22%

On the other hand, winter performance was seen as positive in both years with very little variation in the rating results (Table 4-15).

4.2.2.4 Noise conditions

The perception of the noise conditions shows a minimal variation between the two surveys. Overall the rating decreased in one year, and the variable that increased the most was “other inside noise”. This can be related to an increase of activities in the centre, as it is becoming a more popular renting venue for different activities.

Table 4-16. Noise conditions results: 2013 and 2014 studies comparison

Variable	Scale	Mean 2013	Mean 2014	Variation
Noise: overall	Unsatisfactory - Satisfactory	4.71	4.31	-9%
Noise from colleagues	Too little - Too much	4.25	4.37	3%
Noise from other people	Too little - Too much	4.85	4.93	2%
Other inside noise	Too little - Too much	4.38	4.81	9%
Noise from outside	Too little - Too much	4.05	3.8	-7%
Unwanted interruptions	Not at all - Very frequently	3.61	3.93	8%

4.2.2.5 Lighting conditions

Lighting overall is perceived as more satisfactory in 2014 with glare perception reduced (Table 4-17). Positive comments noted the good natural light conditions while negative comments noted the lack of a lighting switch in the kitchen (in fact there is a lighting switch in the kitchen that was malfunctioning due to control wiring issues as described in chapters 3 and 5 – this problem is now solved).

Table 4-17. Lighting conditions results: 2013 and 2014 studies comparison

Variable	Scale	Mean 2013	Mean 2014	Variation
Lighting: overall	Unsatisfactory - Satisfactory	4.9	5.25	7%
Natural light	Too little - Too much	4.61	4.33	-6%
Glare from sun and sky	None - Too much	3.45	3.2	-8%
Artificial light	Too little - Too much	4.1	4	-2%
Glare from lights	None - Too much	2.95	2.46	-20%

4.2.2.6 Conclusion

In general the results from the 2013 study were satisfactory but the majority of the BUS study variables show an improvement in the following year, namely regarding comfort and safety levels, perceived health benefits, the building's ability to meet the users' needs, lighting conditions perceptions and most notably in the summer environmental conditions perception.

The improvement of the summer environmental comfort results in the 2014 survey highlights the challenges of using cooling strategies that require the users' interaction. In the winter the building runs smoothly with little intervention from the occupants, and this reflects in high levels of satisfaction, which are lower in the summer when effort pro-active approach and a better understanding of building performance is required. Nevertheless, the surveys' results indicate that passive strategies like night purging and use of external blinds viable solutions that can make a difference on the building performance when used effectively.

The two consequent studies highlighted the fact that occupancy surveys are snapshots of the building performance as perceived by its users at a specific point in time, and therefore have to be carried out when the building is fully operational.

4.2.3 Survey results – transient occupants of the building – Summer 2014

The Centre hosts a wide range of weekly activities (bingo, elderly club, bowls, various dancing lessons, children activities, table tennis, etc), alongside special events attended by large numbers of people (weddings, funerals, lectures, etc). Since, overall, the number who visit the Centre on a regular basis is larger than the number of permanent users, it was deemed relevant for the BPE study to investigate the perceived comfort and satisfaction of the transient users with the building. The transient users survey was carried out in the summer of 2014, starting at the same time as the permanent users study. The survey was administered by the TSB evaluator, and the questionnaires were distributed and then collected by the Centre Manager in a secure box. They were available to all members of the public who attended various events in the building for a period of 2 weeks. There were 27 respondents to the survey, and as the answers revealed, all of them had visited the building before, and more than half of them mentioned they visit the Centre 'frequently'.





The BUS methodology indices derived from the study variables indicate that the building has been rated in the upper 80 or 90 percentile of the total buildings currently included in the BUS methodology benchmark database:

Table 4-18. Transient BUS survey Indices

	Mean	Percentile	Scale
Summary	0.83	95	[-3 to +3]
Comfort	1.01	99	[-3 to +3]
Satisfaction	0.65	83	[-3 to +3]
Forgiveness	1.63	99	[-0.5 to +1.5]

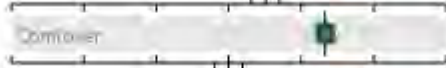
The overall study variables show that, compared to the benchmark, the building is highly rated for aspects such as: overall comfort, satisfaction with the air quality, perceived health, noise, lighting, perceived productivity and indoor temperature.

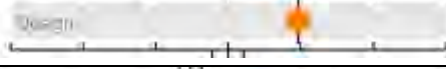
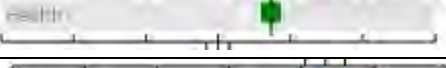
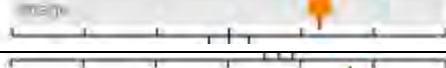
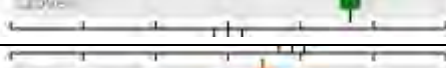
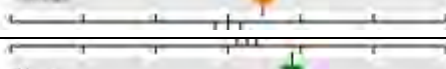
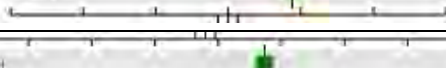
Table 4-19. Transient BUS survey - Overall variables

Variable	Result	Mean	Percentile
Comfort: overall	Unsatisfactory :1  7: Satisfactory	5.33	86
Air overall	Unsatisfactory :1  7: Satisfactory	4.56	81
Design	Unsatisfactory :1  7: Satisfactory	4.96	55
Health (perceived)	Less healthy :1  7: More healthy	4.73	96
Image to visitors	Poor :1  7: Good	5.25	32
Lighting (overall)	Unsatisfactory :1  7: Satisfactory	5.68	96
Needs	Unsatisfactory :1  7: Satisfactory	4.48	25
Noise (overall)	Unsatisfactory :1  7: Satisfactory	4.88	86
Productivity (perceived)	Decreased: -40%  Increased: +40%	7.36	93
Temperature (overall)	Uncomfortable :1  7: Comfortable	4.47	74

4.3 Conclusions and key findings for this section

1. Occupant evaluation studies can provide great feedback for designers as they help to identify the building problems and any design or construction faults that affect the occupants' lives. Additionally lessons from the building in-use are valuable to inform future projects. The interviews with the main parties involved with the building construction and maintenance have proved to be hugely relevant to discuss the performance of the building, providing great insights to how the users interact with the building and its services. Also the results from the BUS methodology study offered a good overview of the users' perceptions on several aspects of performance. Moreover being a standard assessment it generated comparable results with benchmarks.
2. Overall the centre occupants are satisfied with the building performance and the BUS methodology results compare favourably with the benchmark in the majority of variables. The survey was also able to highlight where, in the users' perspective the building has succeeded most and where it has fallen short. They seem to appreciate the overall comfort levels, the lighting conditions, general design features, cleaning levels and image to visitors. Summer general warm temperatures and noise transference seem to be the highest concerns for the users.

3. Nevertheless the Forgiveness Index result (a measure of tolerance of users with the building environmental performance) was very positive indicating that the occupants feel generally comfortable and are willing to overlook their complaints.
4. The first BUS methodology study done in 2013 highlighted a high dissatisfaction level of the users with the summer environmental conditions. However the design team pointed out that the building's cooling strategy was not fully operational at that stage due to a dispute between the contractor and employer resulting from an unexpected funding shortfall. For this reason further funding was found for another BUS methodology study in 2014 by which time the rooflights were operational. Despite being a warmer summer, the BUS study and monitoring during 2014 both found that summer comfort levels were satisfactory.
5. The difference in summer comfort levels between 2013 & 2014 highlights that passive strategies like night ventilation and use of external blinds are relevant strategies that can make a difference to the building performance and user comfort levels. However this also highlights the difficulties of implementing passive strategies that require user interaction: in the winter, when the building runs smoothly with little intervention, the occupants show higher levels of satisfaction, while in the summer when more effort and understanding (eg. night purge cooling & use of sun shading) is required of individuals, there is a greater risk of dissatisfaction.

5 Details of aftercare, operation maintenance & management

5.1 Aftercare, operation and maintenance

5.1.1 Fabric – thermographic report

A thermography survey (attached to this report in full in Appendix 10.4) was carried out on 31 January 2012 to check the heat losses through the building envelope after completion of the project, and further analysis of the survey results carried out using Testo IRSoft v2.7.

The report showed that the building fabric overall performs well, with minimal heat losses through the building. The thermal image of the South elevation below is even more striking due to the contrast between the well-insulated Centre, and the near-by estate leaking heat through uninsulated thin walls and poor PVC frame double glazing. (The research team have carried out a short analysis comparing the indoor conditions in the centre and in some of the near-by flats, described later in chapter 6 Energy use and environmental conditions).

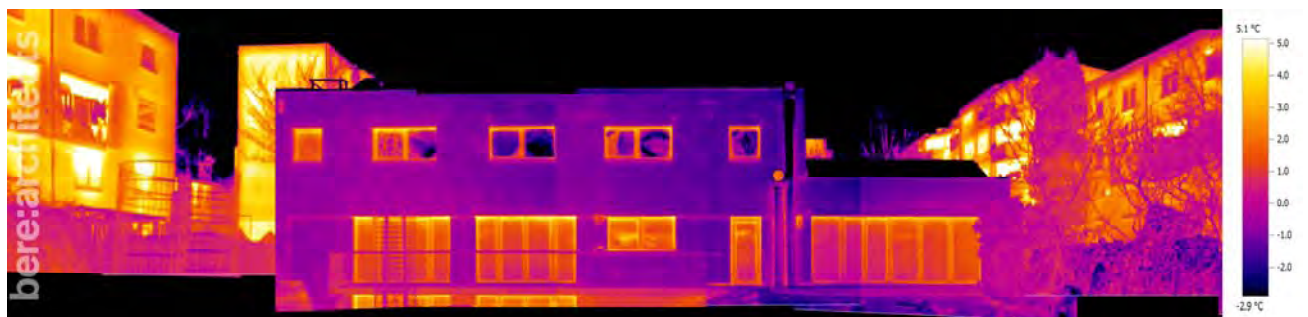

Figure 5-1 Mildmay Centre – thermographic image of the south elevation and near-by estate with high heat losses (note: windows reflecting heat from uninsulated building behind camera)

The results of thermography survey indicated that the external surface temperatures in sub-zero ambient temperatures were significantly lower than adjacent uninsulated buildings (-2°C as opposed to $+2$ to $+4.5^{\circ}\text{C}$). The difference between the external temperature and that of the window panes and the walls is reasonably small. At the same time, the internal surfaces temperatures were very close to internal air temperatures. Overall, this indicates a low rate of fabric heat loss.

However, the survey also highlighted a couple of possible issues. One was the increased heat loss around the junction of south façade balcony doors and wall due to the external venetian-blind louvre system which reduces the amount of wall insulation. Another issue was the air infiltration around some of the external doors. (The doors and windows were subsequently commissioned by the manufacturer and leakage was reduced.)

5.1.2 Issues flagged up by the thermographic report

The report highlighted some installation flaws of the external doors, which were leaking heat. This was due to poor handling, forcing, or poorly adjusted hinges.

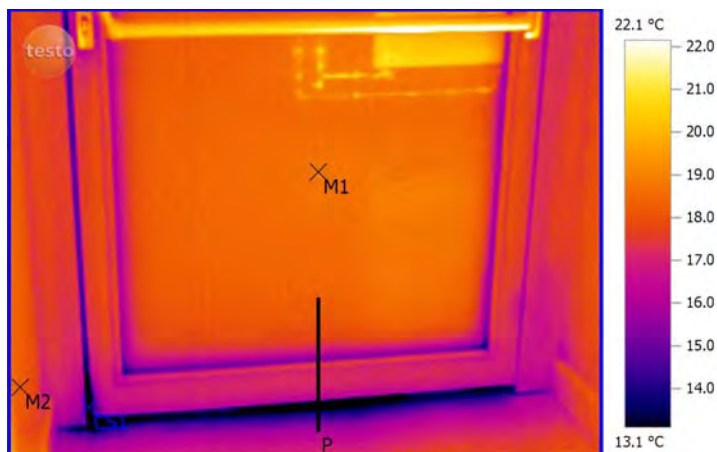

Figure 5-2 Fire escape door –thermographic image

The fire escape door located at the Western end of the building (images above) has been re-adjusted by the German door manufacturer in spring 2014.

The installation of the fire escape door located in the main hall still needs to be repaired (as shown in the images below). The frame was distorted by the site carpenters who installed the windows.

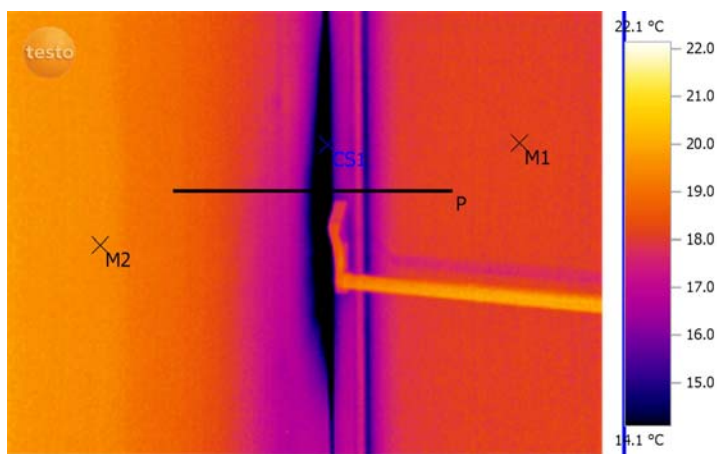
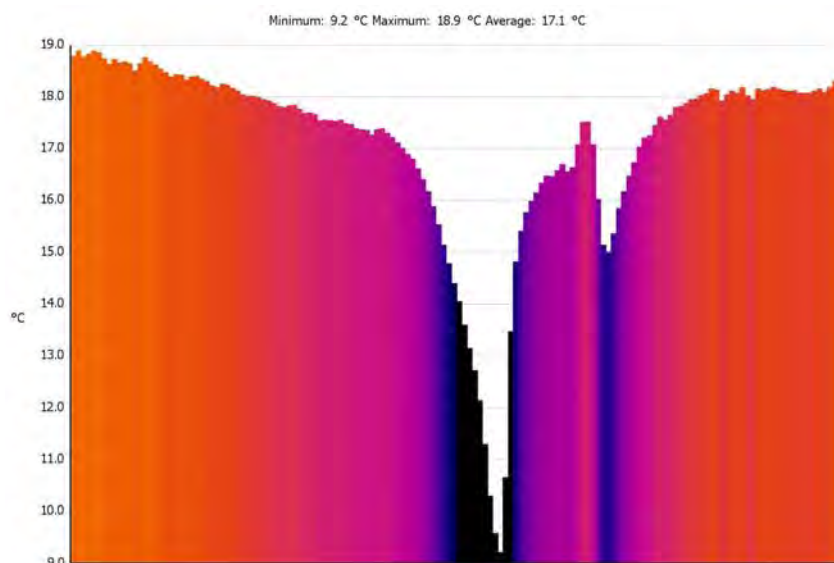

Figure 5-3 Fire escape door- thermographic image

Section P shows that the temperature on the frame and the wall drops below the dew point temperature (usually around 10-12C,it varies according to internal conditions), and therefore can pose risks of condensation where the heat from inside meets the cold surfaces.



Another sensitive detail are the pockets for the external blinds:

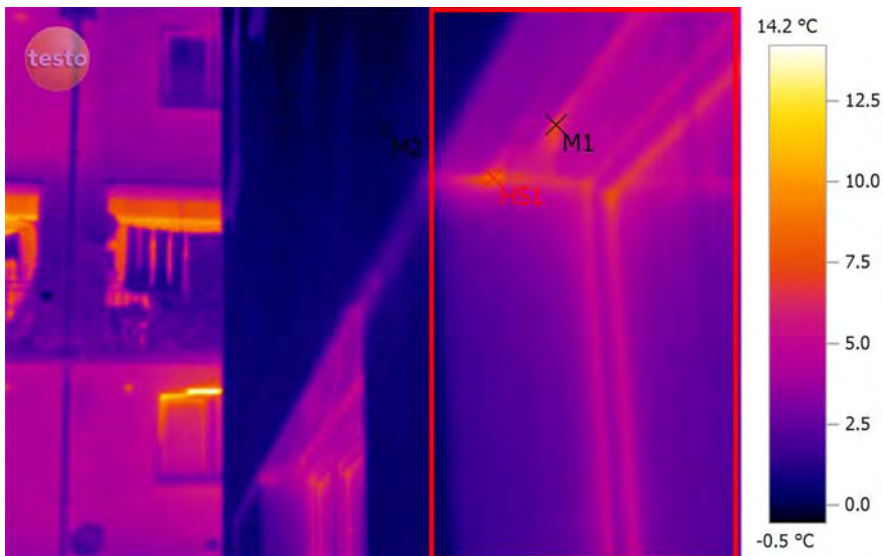

Figure 5-4 External window reveals with blinds pockets – thermographic image

5.1.3 Systems and controls

5.1.3.1 Main hall: Rooflights and ventilation grille



Figure 5-5 Ventilation grille (main hall)

The winter and summer strategies used in the building require two different modes of interaction with the building, tailored for the two seasons.

- In the winter the mechanically ventilated environment was found to provide very good quality air without much interaction from the occupants, other than adjusting a radiator thermostat locally in their offices, if or when needed. The thermostat in the main hall is usually set to 20°C by the Centre's manager.
- In the summer the occupants have been shown how to use the windows and the blinds to create a comfortable environment. The summer requires a much more hands-on approach from occupants than during the winter, although no more is asked of the occupants than they would normally do at home.

It was found that the users seemed cautious of operating the roof lights or the ventilation grille in the morning or at night in hot weather, even though this would help cool the building. This could be due to the fact that it is expected that the Centre's staff manage the day to day operation of the building and its systems.

5.1.3.2 Other controls



Figure 5-6 Reception desk cupboard

The door access, alarms and lighting controls are grouped on surface-mounted power trunking that runs around the area behind the reception desk. The location of the controls is driven by this trunking - a cost-effective way of distributing LV power and data communications cables. Unfortunately, the location of the controls was not informed by (or did not inform) the client's requirements for fixed shelving and cupboards. The cupboards hide some of the switches – in one case a shelf has been installed by the carpenter right across a switch. The photo above shows the switches before the cupboard doors were fitted. This reflects the fact that the budget did not allow for many of the fit-out works to be carried out until after the completion of the building.

5.1.3.3 Labelling

The design team and the client found that there were missing labels on power sockets, switches, and circuits in the plant room and in various rooms. During visits from the electrical sub-contractor or the electrician who helped the team with adjusting the sub-metering layout, the electricians had difficulties identifying different circuits, or understanding what circuit different equipment was connected to. The lack of careful labelling of different features or systems can be identified during the snagging of the works. In this case, although the team noted the lack of appropriate labelling on the snagging list, the fact that the client and the contractor were disputing payments meant that the items on the snagging list were not addressed for a long time, and some are still pending.

5.1.3.4 Supply valve and CO2 monitor in dining area

One design issue the team discovered on site was highlighted by the users of the dining area. When meetings with large groups of people were organised in the dining area, the motorised valves, controlled by CO2 sensors, would open up the dampers and provide a fresh air supply to the room. Within a few minutes, the valves were heard again, closing the supply ducts. This could be distracting for meetings held in the dining area, due to the constant noise from the valves.

The team asked consultant Andrew Farr from Green Building Store to visit the building to assess what the problem was. After investigations, it was found that, since the CO2 sensor was located very close to the supply valves, as soon as the supply ducts were opened, the sensor would record a fast drop in CO2 concentration (even though that was not the case for the entire room), and cause the actuator valve to close the supply ducts. However, within minutes the CO2 concentration would reach the levels of the rest of the room, and call for the dampers to open up again, supplying air. The team learned that for future projects CO2 sensors should be located further from supply air ducts, in order to avoid this type of issue.

5.1.3.5 1st floor supply duct damper



Figure 5-7 First floor ventilation ductwork

Due to the fact that a damper valve became faulty and was subsequently not replaced, the damper for the 1st floor offices remained permanently open on the supply duct, thus providing constant supply to the 1st floor offices in the summer as well as during winter. This means that the energy used by the system will be slightly higher than expected during the summer, however the additional small supply will complement the ventilation through the windows. A detailed analysis of the energy consumption of the ventilation unit during summer and winter is presented in Chapter 6 Energy use and environmental conditions.

5.1.4 Filter changes

The filters were changed by Andrew Farr of Green Building Store with a member of the Centre staff and in the autumn of 2012. The filter change was filmed and included in one of the Soft Landings activities organised by

the design team, and uploaded on their research page: <http://www.bere.co.uk/films/mayville-soft-landings-commissioning-handover> (min 10).

The second filter change was done by the Centre manager in April 2014. As the manufacturers and suppliers of constant pressure ventilation units point out, extremely dirty filters increase the energy used by the fans in order to deliver the same air flow (and maintain the air quality), however if this persists for a long time this can cause damage to the fans and the unit itself. Since for the public this is still quite new technology, as part of their soft landings approach the design team regularly reminds the clients, tenants and managers of all their low energy buildings of the need to change the filters in the ventilation unit. The team noted that after 2 years of monitoring the occupants seem to become familiar with the need to change filters periodically.



Figure 5-8 Dirty filters

The team found that on this, as well as other BPE projects, the client or their maintenance team seem to overlook the importance of changing the filters on the ventilation units, and seem to postpone it until prompted by the design team. Heat recovery ventilation is still a new technology for most people, and it seems that in the UK the maintenance requirements are not readily adopted as a regular practice. For this reason, the design team would like to see visual or audible prompting devices incorporated by manufacturers to encourage maintenance to be carried out when filters are dirty. Suppliers of the original equipment could also play a part by sending prompts (or set up direct debit payments and automatised delivery) when they estimate new filters need to be bought or fitted.

The installation and commissioning of the ventilation systems was found to be successful by the research teams on all Bere Architects' Technology Strategy Board BPE projects. But as explained above filter changing on this project required constant prompting from the design team in order to ensure the filters were changed annually. If the filters are not changed frequently enough, increased energy is required to maintain constant duct pressure and fan motor life might be reduced. Bere:architects continue to try to persuade the Green Building Store to set up a service agreement with landlords to supply filters automatically at appropriate intervals, but there is some resistance from GBS management which it is hoped will be overcome soon. It was found that working with diligent mechanical designers and ventilation suppliers and installers, as well as high quality commissioning methods (eg. using high quality anemometers that account for anemometer bearing

resistance in low-airflow systems, and checking overall intake and exhaust figures to check for duct air leakage) are key factors in achieving good performance. Another key element was found to be the architects' own training to understand how the systems work in practice.

The authors of this report consider that it is important to note that this report found evidence that reliable methods are available to ensure consistently successful installation and commissioning of heat recovery ventilation systems.

5.1.5 Rainwater harvesting tanks & pumps

During the spring of 2014 the Centre's managers found that the flushing of the toilets wasn't working. They contacted the Aqualite rainwater harvesting pump maintenance team over the phone, who advised that a visit to site was needed and that the pump should be set to receive water from the water mains in the meantime. Due to lack of funds, the maintenance team visit was postponed until early August.



Figure 5-9 Aqualite rainwater harvesting pump

Once on site, the maintenance team explained that once the Aqualite pump cover is removed, a yellow light will show that the pump is using the water from the mains, or if the black button next to it is pressed, the green light will show that the pump is using rainwater from the tank under the garden deck.

The maintenance team found that a sensor was incorrectly positioned in the rainwater tank. When in a vertical floating position, the blue sensor bubble sends a signal to the pump to indicate that there is water in the tank, or, if it's flat, that there is no rainwater and the pump then switches to the mains. The cord of the sensor was too long, hence the sensor had shifted to a flat position too early, erroneously indicating to the pump that there was no water in the tank. This was towards the end of a long dry period when the level of the water in the tank dropped. It is very reassuring that even towards the end of a long, dry summer there was still sufficient rainwater in the tank to supply wc requirements. Once the cord was shortened and the problem was fixed, the pump started immediately to send rainwater to flush the toilets. The fresh water used from the mains during these months could have been saved had the site visit been scheduled earlier, however this was difficult to arrange due to the Centre's lack of funds.

Another recurring issue was the power to the pump in the rainwater tank collecting water from the green roof, which is used to water the garden via garden taps. The connection to power is done via a protected socket located in a manhole under the terrace deck, next to the kitchen exit door. Although it is still unknown what

caused the pump to stop on several occasions, the pump started working again once the plug was re-plugged in the socket. Unfortunately, on each occasion the users of the garden watered the plants using mains water until the plug was pulled out and re-set.

5.2 Metering strategy and issues

5.2.1 Summary of sub-metering strategy, initial and upgraded

The occupants moved into the refurbished building in the summer of 2011. The initial monitoring equipment was installed by the main contractor, part of the *Building Regulations* requirements. One of the key elements of building performance analysis is determining the amount of energy used in the building's operation. The purpose of the sub-meters is to enable the design team and the building's occupiers to apportion energy use to the various end-uses in the building.

In the first work stage (Feb 2012), the manual weekly readings of the sub meters revealed that not all of the readings were accurate, and the information did not cover all the energy generation and consumption processes in the building. The design team worked with Rod Bunn of BSRIA and a skilled electrician (Michael Webber) to draw conclusions about the system and to propose improvements in order to obtain a comprehensive set of monitoring data which would accurately describe the energy use of the building.

These findings were recorded in a Sub-metering report which is attached in Appendix 10.7.

After analysing the sub-metering layout and the monitoring data, the first conclusions were:

- The Ground source heat pump (GSHP) has a 3-phase supply (the M&E sub contractor was not fully aware of this and consequently wired the sub-metering only for 2 phases). The 1st and 2nd phases are connected in the main *MCCB Distribution Board* (DB) in the plant room and were separately sub-metered. The 3rd phase, located in the smaller *DB Basement* distribution board in the plant room, was not metered.
- The sub-meter labelled '*DB1 PV plant room*' records the power to sockets and lights from the 1st floor Distribution Board, located in the Photovoltaics (PVs) technical room on the 1st floor. The sub-meter needed to be re-labelled '*Distribution Board - 1st floor*'.
- The sub-meter labelled '*PV Export*' showed actually PV generation, and was linked to the main PV meter on the 1st floor technical room. The submeter is installed inside the main *MCCB Distribution Board* in the basement, and the energy generated by the PVs is directed straight to the Bus Bar of the *MCCB board*. The readings from week to week showed a good correlation with the PV main meter on the 1st floor. The sub meter stopped recording between 17.04.12 – 08.05.12. An electrician called on site by the design team found out this was due to a tripped switch within the main PV meter.

- There was no export meter, which would enable the design team to assess how much of the energy generated by the PVs was actually used in the building, and how much exported back to the grid. This meant that an accurate estimate of the actual energy consumption of the building was not possible. The PVs are a 18 kWp array, and EDF (when contacted by the design team) answered that the building does not qualify for a feed-in tariff (and therefore an EDF export meter) with an array under 30 kWp.
- As a consequence, some of the initial analysis had to assume that all the energy generated by the PVs was used in the building.

Weekly readings were useful for recognising a trend, and indeed for indicating that there was a problem with the meters, but in order to understand exactly what was happening with the meters, the team felt it was necessary to explore the issue at a finer level of detail. After discussions with the external consultants on the team (M&E - Alan Clarke, and independent energy consultant Roderic Bunn), the design team commissioned several new sub meters which would cover the grid import and PV export, and the 3rd phase of the GSHP, and also pulse counters and a hub which would send wireless information, every 5 minutes, to an online depository. The pulse counters were fitted to the main energy generation sub-meters (grid and PVs) and renewables sub-meters (HRV ventilation fan, GSHP).

Also, a series of environmental sensors (temperature, relative humidity and CO₂) were deployed in key rooms of the building, as well as an external weather station. The sensors were connected to the same hub, sending valuable data about how the building was performing.

5.2.2 Minimum sub-metering required by Building regulations – initial set-up

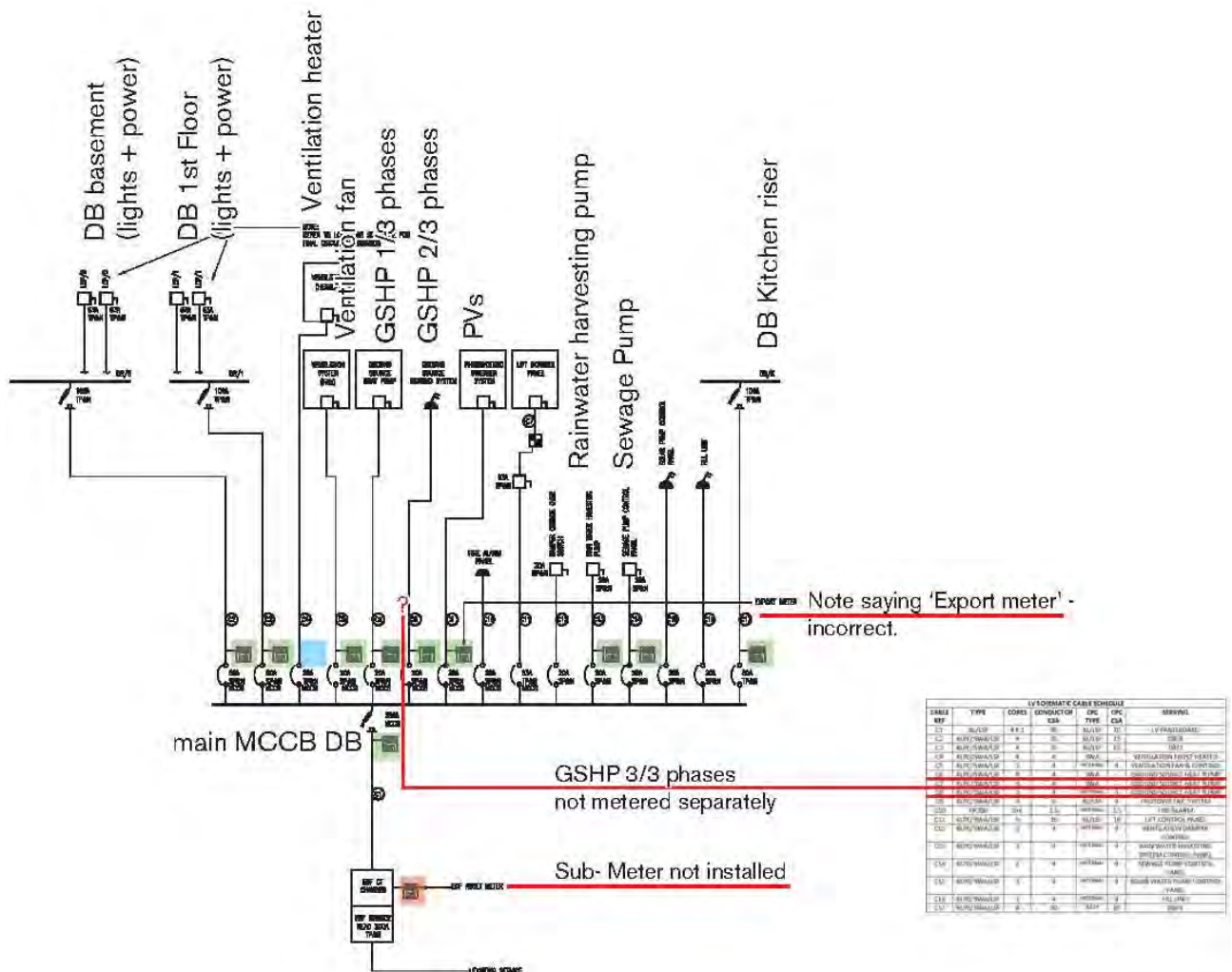

Figure 5-10 M&E subcontractor’s ‘as built’ electrical diagram with b:a notes (in colour)

The design team made some notes on the ‘as-built’ schematic (above) produced by the M&E subcontractor, indicating:

- existing sub-meters on site, matching the M&E schematic are marked in green.
- there are three GSHP circuits in the table on the side, however only two were sub-metered in the schematic, as well as on site. The 3rd phase is included in the Basement Distribution Board, and therefore metered alongside the basement lights and power.
- the ventilation heater (frost coil) did not appear to be sub-metered on the diagram- when actually on site it is metered. (This has been added to the diagram above – see blue square in diagram above)
- the ‘Photovoltaics inverter system’ appears metered, however with a note to the side indicating ‘Export meter’ - the sub-meter actually measures PV generation
- a sub-meter is indicated below at the main EDF meter - the electricity grid import - however this was not sub-metered on site (in red)

The team found on site that the initial set up of the energy monitoring equipment to measure electricity consumption (kWh) did not cover all the renewables (one of the GSHP 3 phases was not metered separately), and did not account for the energy imported and exported back to the grid. Given these findings it was argued that the sub-metering set-up was not compliant with the building regulations requirements. This should have been checked and raised by the main contractor with the electrical sub-contractor who was paid additional money specifically to produce and implement this detailed design.

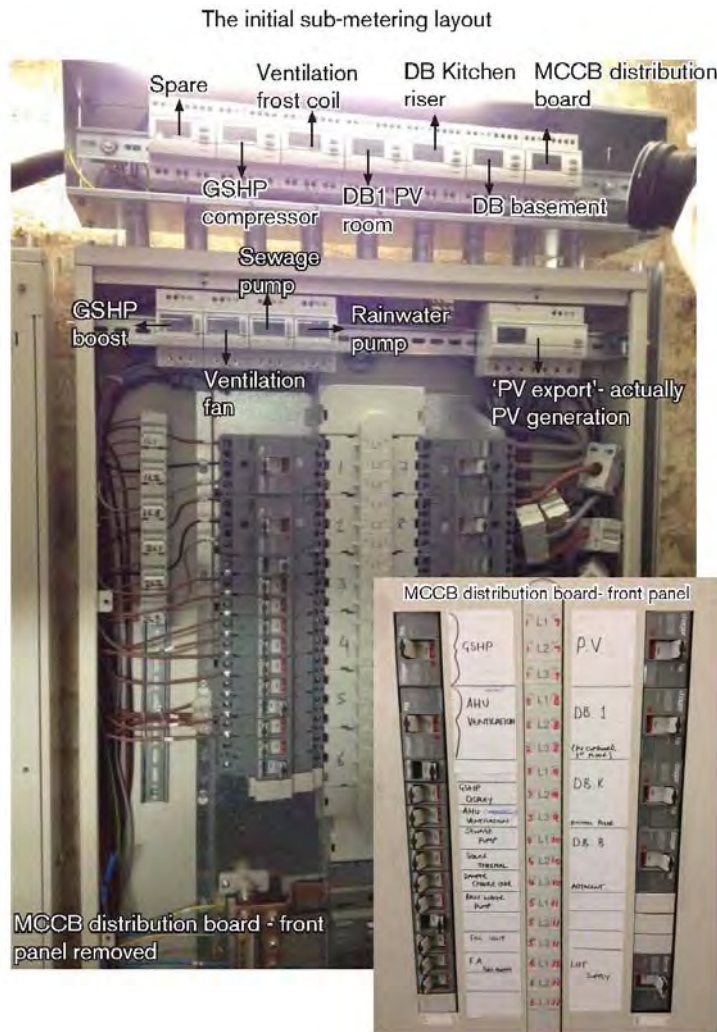

Figure 5-11 MCCB distribution board with sub-meters

5.2.3 Additions and upgrades to the metering system

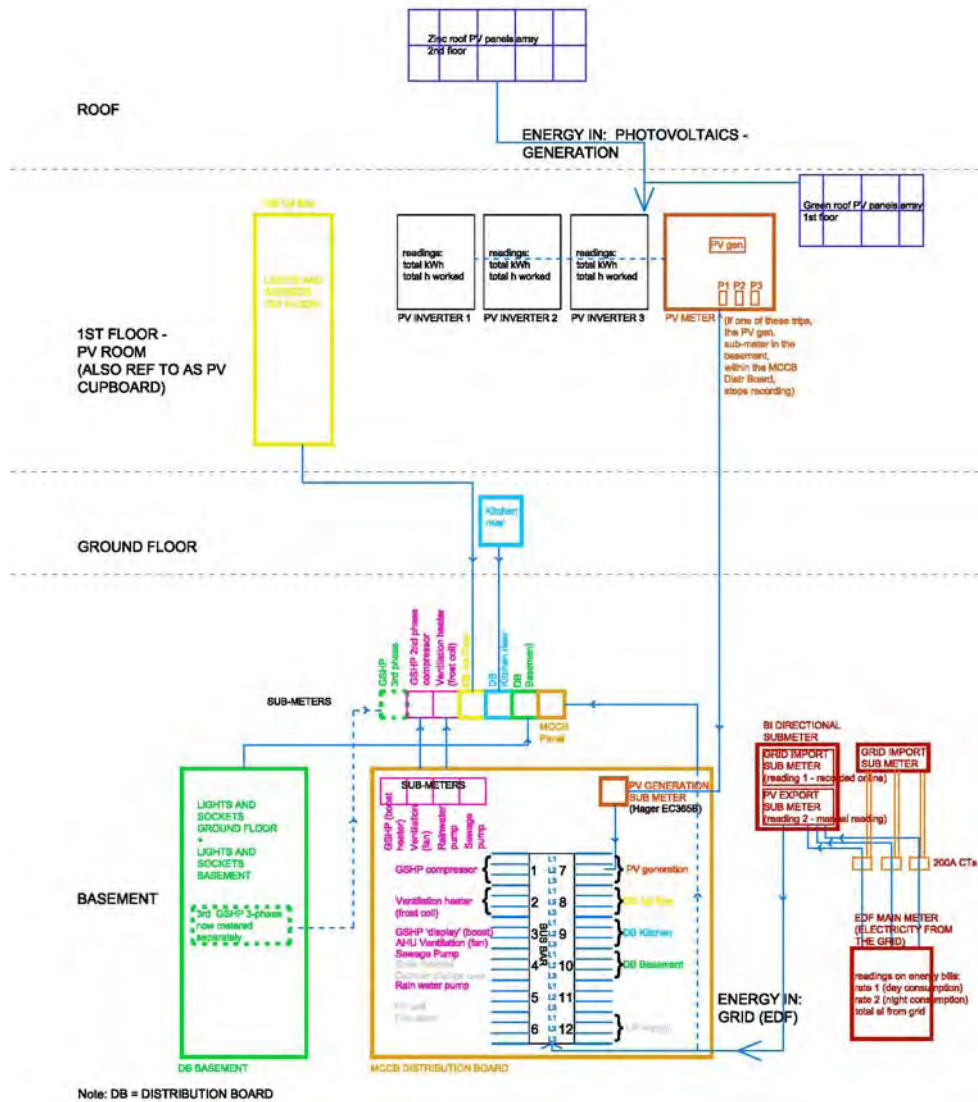

Figure 5-12 Sub-metering schematic

The design team labelled or re-labelled the sub-meters where necessary and employed an electrician to add new meters as required in order to be able to assess the total energy consumption of the building, and of each of the low energy technologies used.

The current sub-metering layout is as described below:

- separate sub-meters for the 3 phases of the GSHHP (direct heater, compressor, and pumps & controls)
- separate sub-meters for the ventilation: the frost protection heater and the ventilation unit fan

- sub-meters for the lights& small power(sockets) separately for the 1st floor, ground floor and basement
- new sub-meters for the lights and power of the architects' own office in the basement, and the power in the music studio in the basement
- separate sub-meter for the kitchen electricity consumption on the ground floor
- sub-meters for the rainwater collection pump, and the sewage pump, which are connected to the two separate tanks located under the garden terrace (one collecting the rainwater from the green roof to be used to irrigate in the garden, the other collecting the rainwater from the main zinc clad roof to be used in the building for flushing the toilets)
- PV generation sub-meter, which records the overall electricity generated by the PV panels on both roofs (and matches the PV generation main meter located in the PV room on the 1st floor next to the 3no. AC/DC current inverters)
- 2 new sub-meters recording the PV exported back to the grid and the electricity imported from the grid, matching the main electricity meter in the building. The PV export meter has become faulty, was replaced once, and then became faulty again in April 2013.
- A sub-meter recording the overall consumption of the loads in the main distribution board (MCCB).

After the existing sub-meters have been accurately labelled and the new sub-meters installed, the design team decided that a better resolution of the monitoring data would add more detail and information to the analysis of the building performance.

It was decided to install wireless pulse counters on the main sub meters which collect data regarding the total energy consumption of the building (grid import and PV generation) and the renewables (the ventilation fan, the 3 phases of the GSHP) and pulse a meter reading every 5 minutes.



Figure 5-13 Wireless data collection

The data is collected by a wireless hub which can then be downloaded from any computer or handheld with an internet connection.

The design team checked that the wireless hub was receiving data correctly and all channels were found to be receiving signals. The data shows the cumulative total of the energy sub meters, but not the total amount of electricity used within each 5 minute time period. The design team downloads the data and analyses it to obtain the increments between every 5 minutes, and then totals for energy consumption per day, week or month.

Due to the faulty PV export sub-meter which was on error since April 2013, the missing PV export metered data and the total energy consumption have been calculated by extrapolating the previous trends identified during the months when the sub-meter was working, when the building total energy consumption compared with the sum of all the sub-metered data together with other constant non-metered loads, and using the PV total generation and grid electricity metered data.

The system also allowed for other sensors to be installed, including temperature, relative humidity (RH) and CO₂ sensors which were installed in key spaces throughout the building, alongside external sensors for temperature and RH. A detailed report on the installation of the additional monitoring sensors, plans showing their location and the initial data analysis was gathered in the 'Monitoring equipment installation report' which was submitted in the 2nd quarter of the BPE study and is attached to this report in Appendix 10.8.

5.3 Maintenance and management processes

The maintenance and management issues highlighted during the 2 year BPE monitoring study can be divided into 2 categories:

Fabric:

- The airtightness layer is located behind the external insulation layer, but can be locally damaged for new service penetrations into the building (such as installing an intercom system at the entrance door). The Centre managers are aware of the existing options to deal with this (eg existing services grommet already installed at roof level).
- The triple glazed windows are extremely resistant to impact, but cracks in the outer glazing pane of a fire door caused by vandalism need to be monitored and the glazing replaced when necessary.
- External insulation: no problems were reported with the maintenance of the external insulation or render system.

Systems and services: The Centre does not have a dedicated Facilities Manager, therefore this role falls to the Centre Manager. The team logged the maintenance activities which arose during the 2 years of study and noted:

- The MVHR: A filter replacing schedule for the ventilation unit could be of help to ensure the filters are changed regularly. The Centre Manager does now have a diary reminder set up on her computer. The summer/winter strategies switch located in the plant room was already mentioned in the report in Chapter 3. The damper valve installed on the supply ductwork going to the 1st floor offices still needs replacing. The manager of the Centre is aware of, and using, the ventilation run-on timer installed by the design team to delay the night time shut down of the ventilation system when there are events running outside the usual operating hours.
- The GSHP: there were no maintenance issues reported. There was a one-off visit to adjust the settings for the Pasteurisation cycle against Legionella.
- Rainwater storage pumps: required maintenance visits (as described in Chapter 3). The tank that stores rainwater for irrigation from the green roof requires periodic filter cleaning.
- Solar thermal: no maintenance issues reported.
- Photovoltaics panels: no maintenance issues reported.
- Blinds: the wires guiding the blinds need the correct brackets and since the contractor did not commission the anemometer to retract the blinds in high winds, some damage has been caused to some of the blinds. A quote is currently being prepared by a specialist (Nov 2014) to carry out the necessary repairs and commissioning. The Centre manager is using a seasonal awareness strategy to alert the occupants and tenants as to how best to use the blinds to make the most of the solar gains in the winter and to protect from overheating during the summer.
- Rooflights: control switch battery ran out, rain sensors installed only this summer. One rooflight was reported not working in autumn 2014 (permanently closed).

The design team noted that there are very few staff running the centre, and most of the staff work part time or are volunteers. It is important that the permanent and volunteer staff are well informed as to the day to day operation of the building, as well as the maintenance issues mentioned above.

5.4 Conclusions and key findings for this section

Throughout this study, the design team and other consultants learned several valuable lessons which could be summarised as follows:

1. the monitoring data has to be constantly interrogated and correlated with manual readings of main meters to check if the information is authentic and viable, and constant (power cuts may trip switches, valuable monitoring data may be lost).
2. the M&E contractor needs to be willing and the engineers on site able to understand what the data will be used for, and what is the best way to produce the relevant information, so that is reflected in the way the electrical installation is designed (the contractor had responsibility for detailed design of the electrical installation).
3. the metering systems used for domestic schemes might not be suitable for larger, non-domestic projects, and it is good to check beforehand if the type of sub meter to be used is appropriate for obtaining the information required by the design team
4. considering that minimal sub metering is a part of *Building Regulations*, clear and accurate labelling of circuits, sub meters and loads within distribution boards should be common and good practice by now - but unfortunately it isn't, and there is a clear need for official guidance and perhaps checklists for Building Control Officers to ensure metering systems are functional and fit for purpose. This is desirable for *Part L* compliance, but also to ensure that installations provided under the Green Deal can be monitored properly. It is proposed that a key outcome of this BPE project should be a tightening of *Building Regulations* requirements for allocating sub-meters to end use loads. Had this evaluation not been carried out there simply would not have been the time or resources available to the client to resolve this problem, and without pinpointing the problems, the contractor would have been under no obligation to put them right.
5. The design team needs to work closely with the commissioning manager (if there is one) during the monitoring period, and more often than not will need to be able to understand specific M&E problems in order to coordinate all the sub consultants and to obtain the required information
6. as in some of our other projects, investing time and effort into getting people involved and obtaining pertinent data, rather than 'ticking boxes', proves to be worthwhile and increases the knowledge basis for everyone involved (design team, consultants, electricians, and clients).
7. Supply contracts should be set up at handover for periodical replacement of new ventilation filters. If a filter is delivered to premises it is more likely to be fitted than if it is left to the building manager or owner to remember when and who to order the filter from.
8. From a maintenance point of view it was found that the low energy systems and services installed in the building do not require any more maintenance than other more traditional systems.

6 Energy use and environmental conditions

6.1 Energy use¹

The energy use of the building was monitored via the sub-meters installed by the sub-contractor and the additional meters installed by the design team after the BPE study had begun. The initial analysis showed that some of the meters were wrongly labelled (as previously described in more detail in Chapter 'Details of aftercare, operation, etc'). The sub-metering layout was changed to include the PV export meter, and a new meter recording the GSHP direct heater contribution after it was found by the design team to have not been previously connected inside the GSHP by the main contractor. New environmental sensors recording temperature, relative humidity and CO₂ levels were installed by the design team in key rooms in the Centre. The analysis of the energy consumption of the building indicates that:

1. The total metered grid electricity consumption, for heating and all other uses, for the 12 months up to July 2014 (year 2) was 39031 kWh/year, equivalent to 48.8 kWh/m².year, while in the previous year (August 2012 to July 2013) the grid consumption was 42.4 kWh/m².year. (There was a higher occupancy of the building in year 2 compared to year 1).
2. In the second year, from the total metered electricity generated by photovoltaics (PV) on site was 14,435 kWh (18kWh/m² year). An estimated 11,143 kWh (13.9 kWh/m² year) was used in the building. Due to a faulty PV export sub-meter which was on error since April 2013 until the time of writing this report, only the PV generation was continuously metered and the building total energy consumption was calculated after April 2013 by using the total sub-metered data, together with other constant non-metered loads (see Appendix 10.19). The renewable electricity generated by the PV, and actually used, was approx. 22% of the total energy consumed in the building.
3. A total energy consumption of approximately 55.64 kWh/m².year was calculated to have been used in the building in the year 1, and a total of 62.7 kWh/m².year was calculated to have been used in the year 2 ending in July 2014, provided by the electricity grid and the renewable electricity produced by the PV's and used in the building. This compares to the raw TM46 benchmark at 190 kWh/m².year typical energy use for seasonal public buildings (community centre sub-type), a hybrid ECON19 'good practice' benchmark at 167 kWh/m².year, defined by BSRIA using a pro-rata calculation to account for the fact that the Centre has both spaces used for community centre, and offices.
4. An analysis of the total metered energy consumption of the building and the energy consumption predicted at design stage (using the Passivhaus Planning Package - PHPP), and then incorporating data regarding the actual occupancy of the building, showed that the PHPP software estimates the actual energy use of the building within 10% accuracy (as shown further in this chapter).

The small difference between the design assumptions and the use after completion were due to:

¹ All the data in this chapter has been calculated using the SAP GIA 800m² area, and not the Treated Floor Area of 665m² used by the Passive House Planning Package (PHPP), for ease of comparisons with other similar TSB funded BPE projects

- changes in the occupancy use and patterns, with meetings and workshop rooms converted into office spaces, with permanent users and full IT and office equipment, including 7 servers on 3 floors (basement, ground and 1st floor)
- increased occupancy hours compared to design assumptions, changed from temporary use to a full time basis
- changes in the light fittings actually used on site: due to budget restrictions. There were fewer light fittings than assumed at design stage, but used more frequently or left on for longer periods of time, with the controls not properly commissioned until August 2014.

The TM22 analysis done for the 12 months up to December 2013 indicated that the majority of the regulated loads (heating, ventilation, cooling, hot water, lighting and pumps) are covered by the energy produced on site (within 10% difference), rendering the building close to 'zero carbon' under the current official definition².

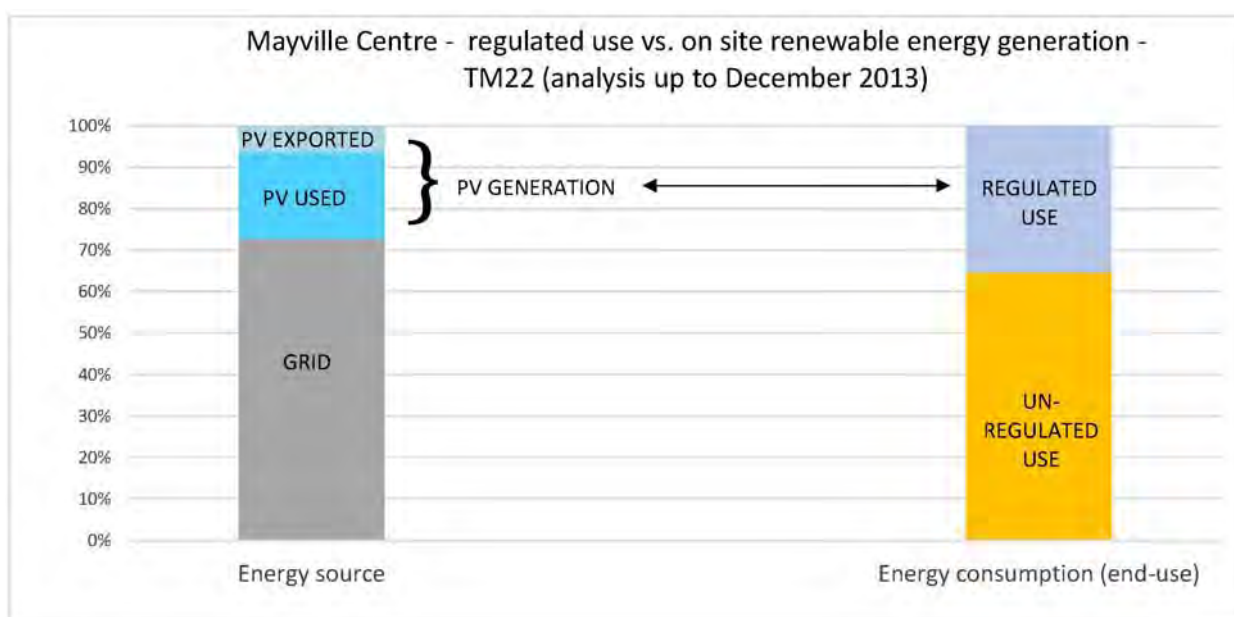

Figure 6-1 Regulated use vs. on site renewable energy generation – TM22 analysis (up to Dec 2013)

The breakdown of the energy consumption by use indicates that most of the energy used in the building is for small power and lighting (approx. 85%).

² Zero Carbon definition as described in The Plan for Growth, 2011

https://www.gov.uk/government/uploads/system/uploads/attachment_data/file/221514/2011budget_growth.pdf

The zero carbon homes standard will require all carbon emissions arising from energy use regulated under Building Regulations to be abated. Regulated energy is that from such things as heating, hot water, ventilation and fixed building services. It does not include appliances.

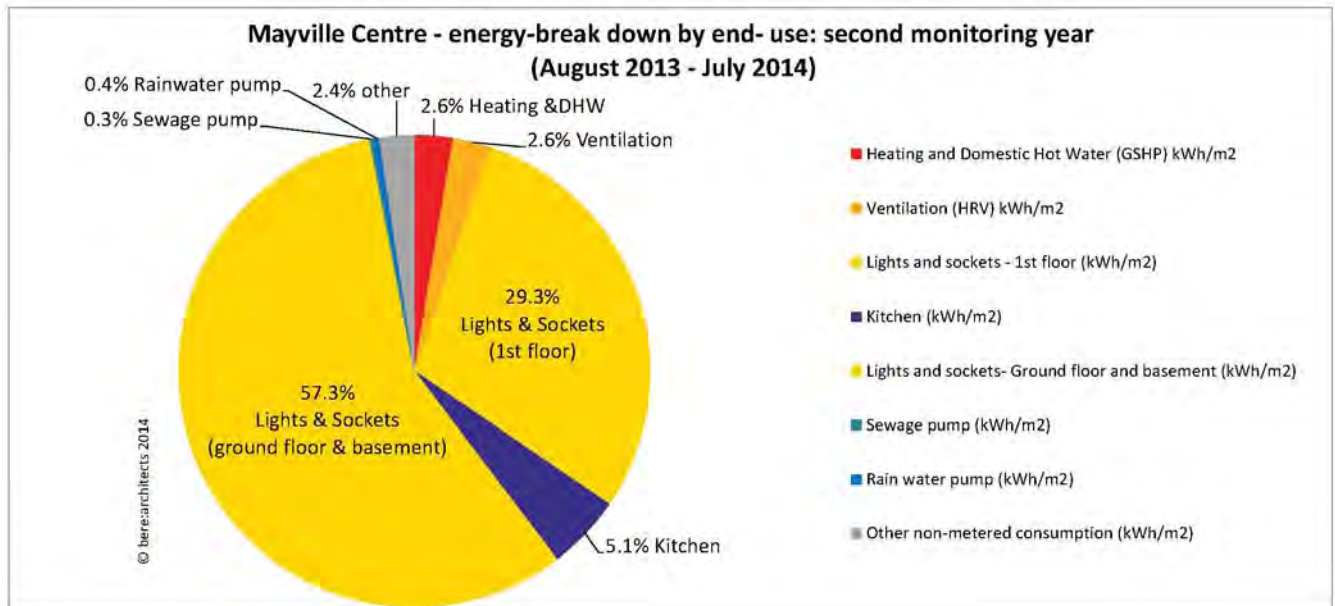

Figure 6-2 Energy break-down by end-use: second monitoring year

A comparison between the two years (August 2012-July 2013 and August 2013 –July 2014) shows that with increased occupancy the lights and power consumption on all floors has increased as well.

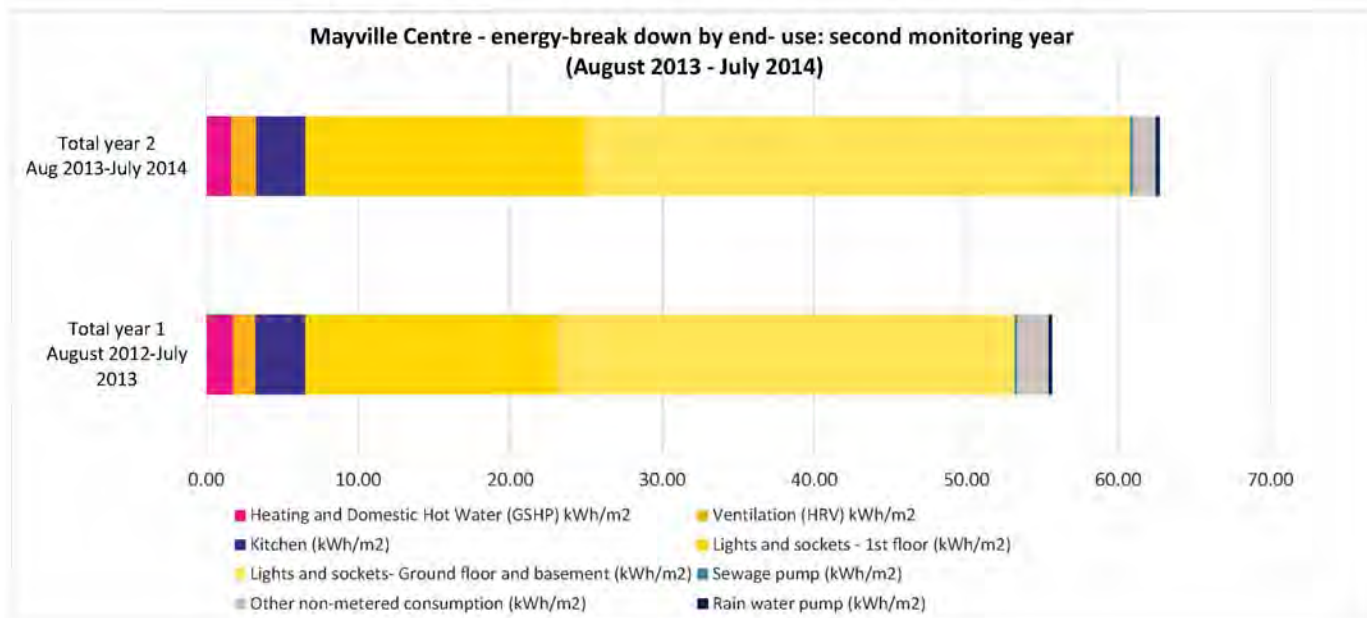

Figure 6-3 Energy break-down by end-use: second monitoring year (August 1013- July 2014)

6.1.1 The ground source heat pump (GSHP)

The GSHP provides heating and domestic hot water, and the sub-metering indicates very low energy consumption (2.6 kWh/m².year in the second year of monitoring, ending July 2014). The direct heater which provides top-up electric heating found not to have been connected inside the GSHP in May 2013.

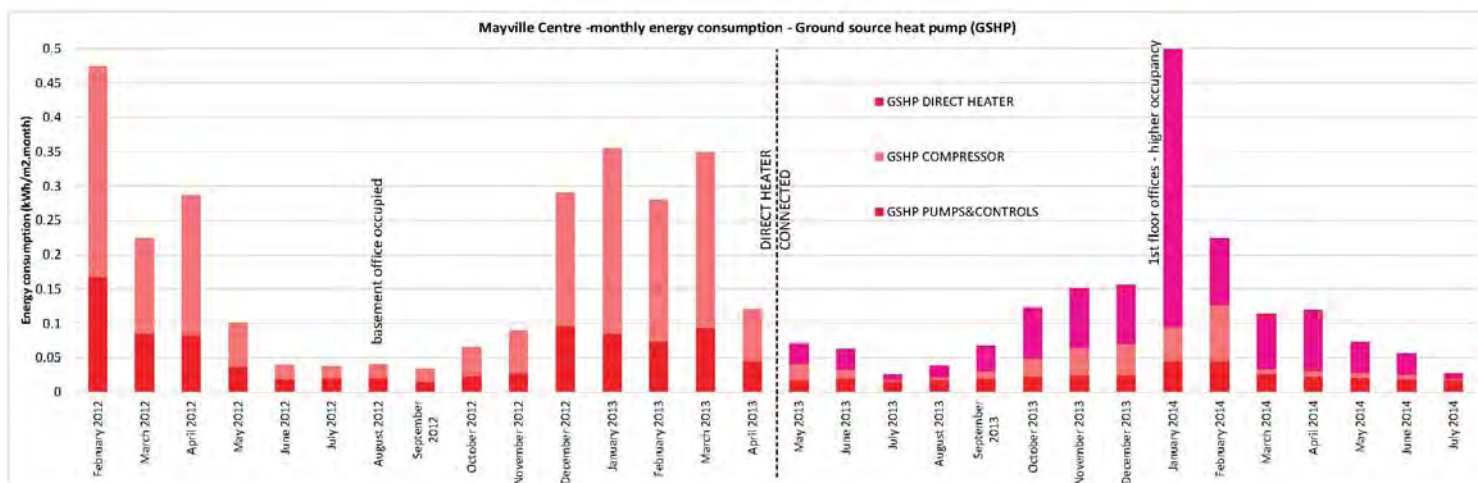

Figure 6-4 GSHP energy consumption

The readings for January 2014 showed a higher than usual energy use by the direct heater. A detailed analysis (overleaf) indicates that when external temperatures dropped below 5C, the GSHP direct heater (pink, top bar) was used repeatedly to maintain indoor temperatures in the double height main hall of 21-23°C in January 2014 and a little less frequently in February 2014 in spite of even higher indoor temperatures in the double height main hall of 22-24°C. The results indicate that the thermostat temperature was set to a high indoor temperature, calling the GSHP for a higher temperature than could have been achieved solely by the compressor.

During the winter it was noted that:

- During events with large numbers of attendees, the entrance door near the reception desk tended to be left on the hold-open setting for long lengths of time, to allow participants in the Centre without staff needing to press the automatic door opener under the reception desk, and to allow staff to smoke without having to open the door with a key to let themselves back in.
- During the winter months the tenants on the 1st floor had more staff joining their offices, and an additional desk was installed on the open-plan upper landing of the stairs, facing the main hall. The area is directly connected to the open staircase and the entrance hall, and therefore can experience draughts when the entrance door is left open.

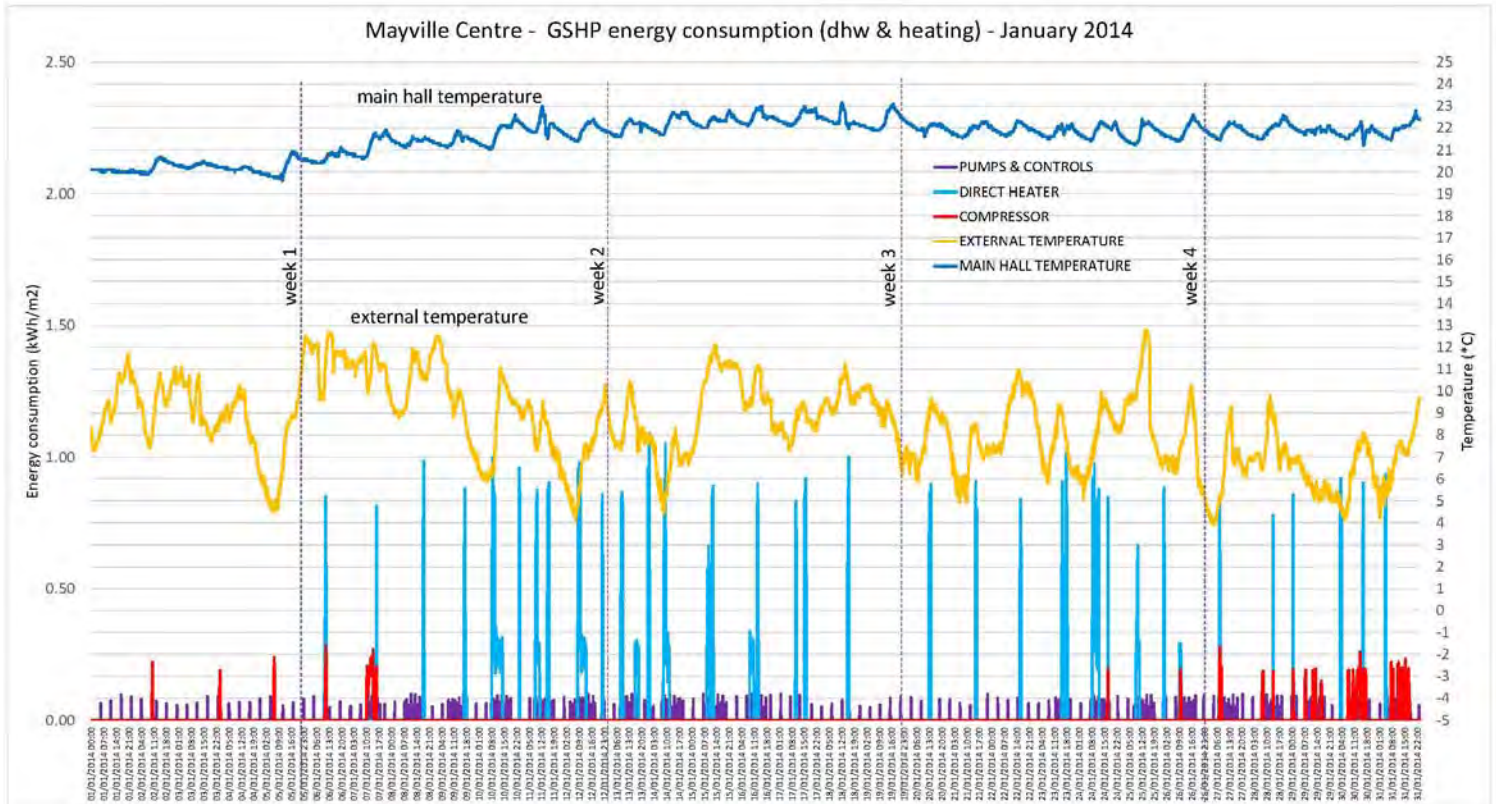

Figure 6-5 GSHP energy consumption (DHW& heating) - January 2014

A comparison between February 2014 (below) and July 2014 (overleaf) shows the difference in the use of the GSHP and the direct heater between a winter month and a summer month when the GSHP is used to back up the solar thermal panel for domestic hot water only:

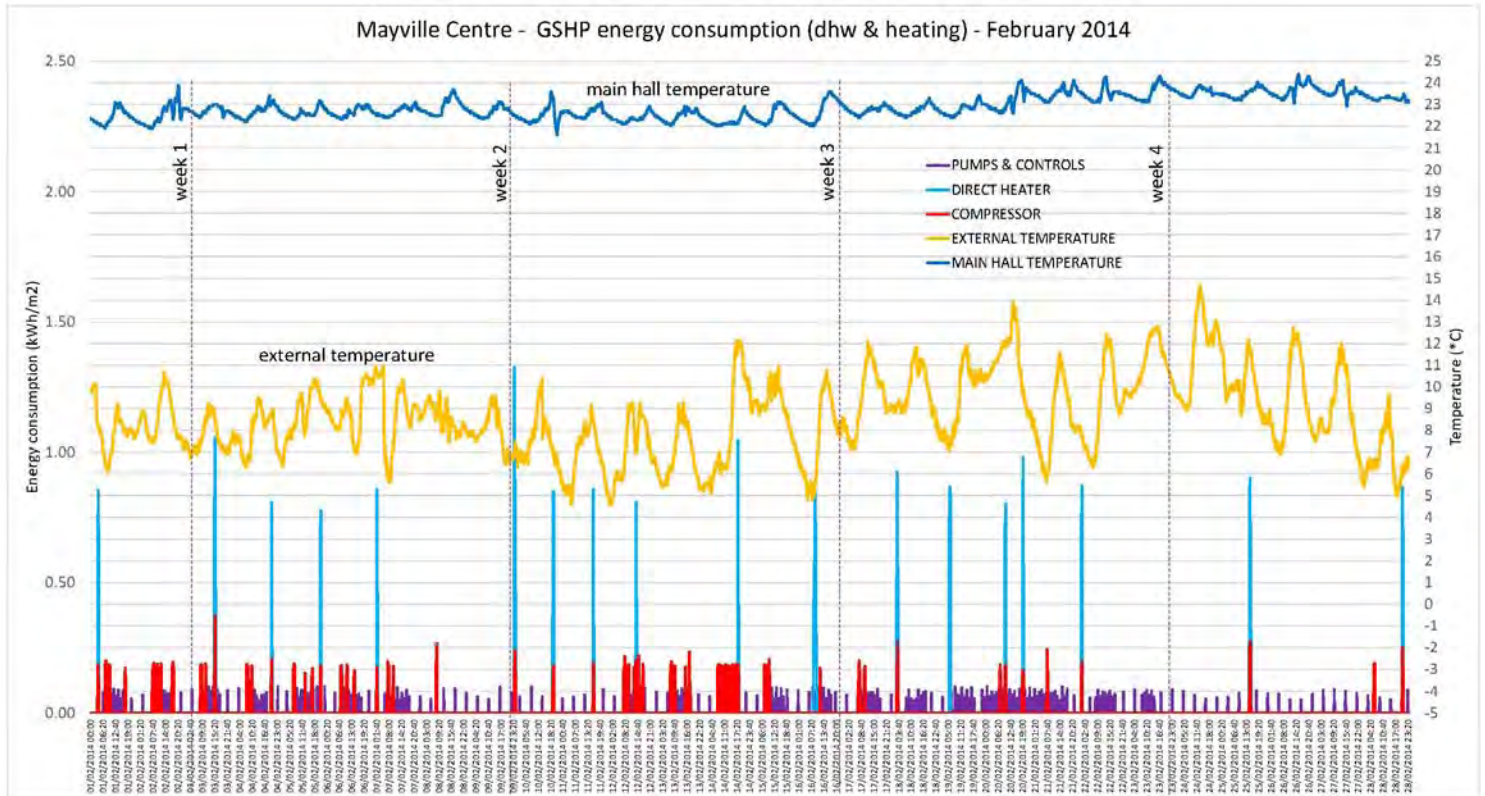

Figure 6-6 GSHP energy consumption (DHW& heating) - February 2014

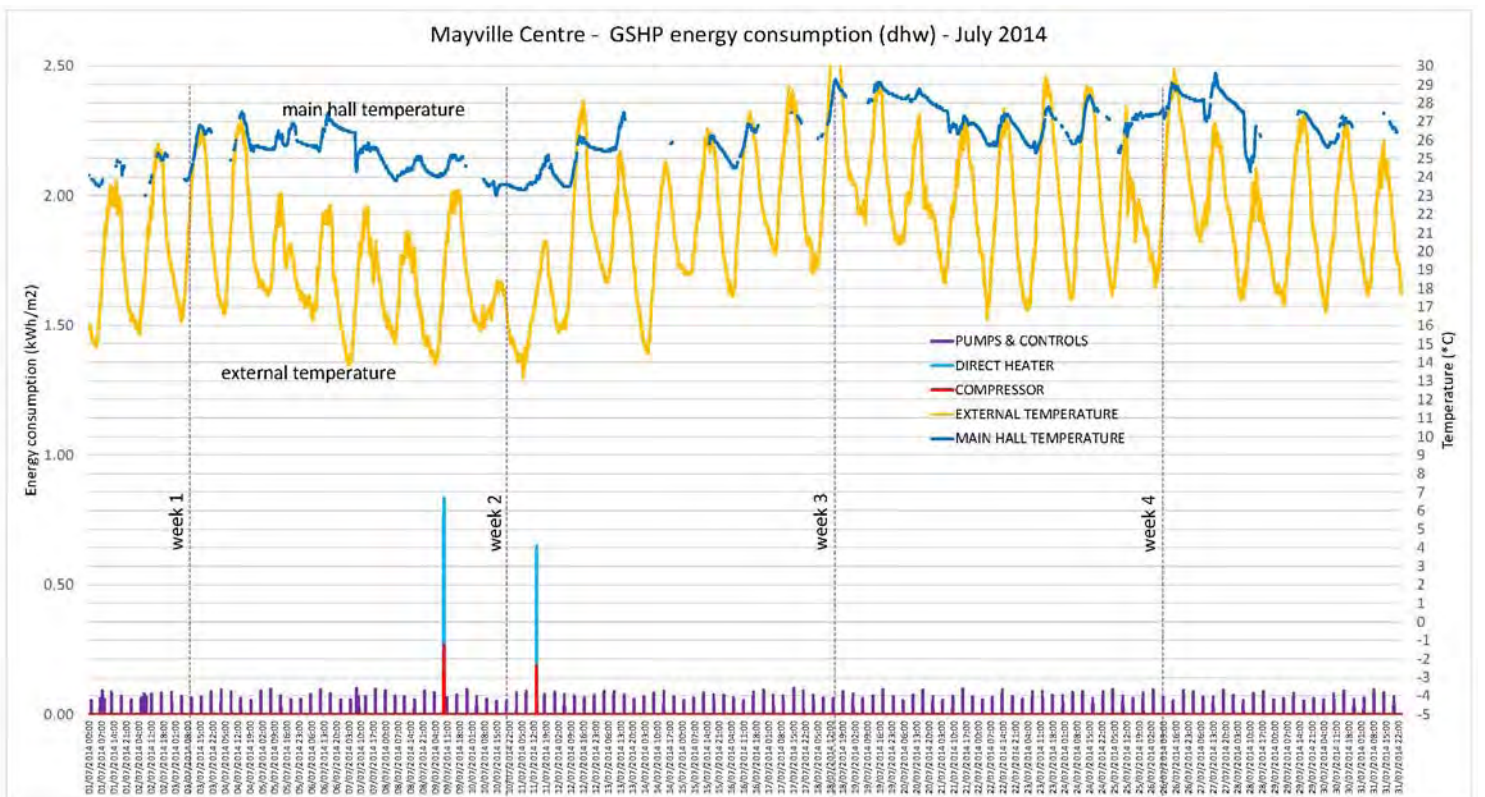

Figure 6-7 GSHP energy consumption (DHW& heating) - July 2014

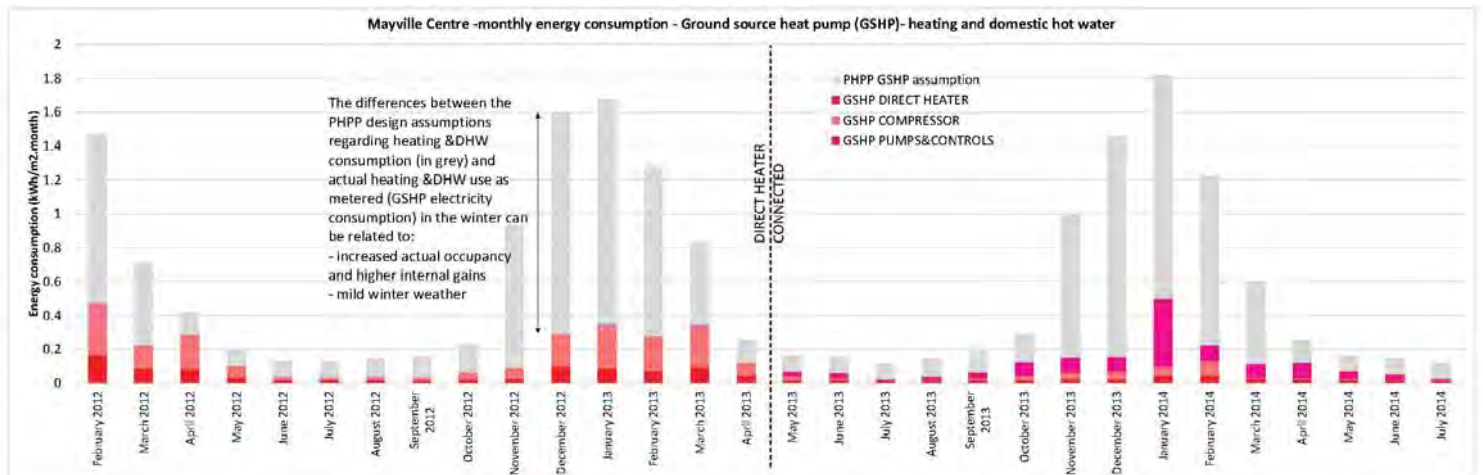

Figure 6-8 Comparison between the energy consumption of the GSHP at design stage and in use (metered data)

The metered electricity consumption of the GSHP is much lower than the figures assumed during the design stage in PHPP. This difference is thought to be due to higher occupancy than expected, compared to assumptions made during design stage, resulting in higher internal gains from people, appliances and equipment. (See Appendix 10.19).

The Coefficient of Performance (COP) of the ground source heat pump was not measured in this project because the necessary heat metering equipment was not included in the funding bid. This was a low-cost research project which focussed on the minimum of intervention in order to try to simulate a process that could affordably be replicated widely on other non-domestic projects in the future.

6.1.2 Heat recovery ventilation unit (HRV)

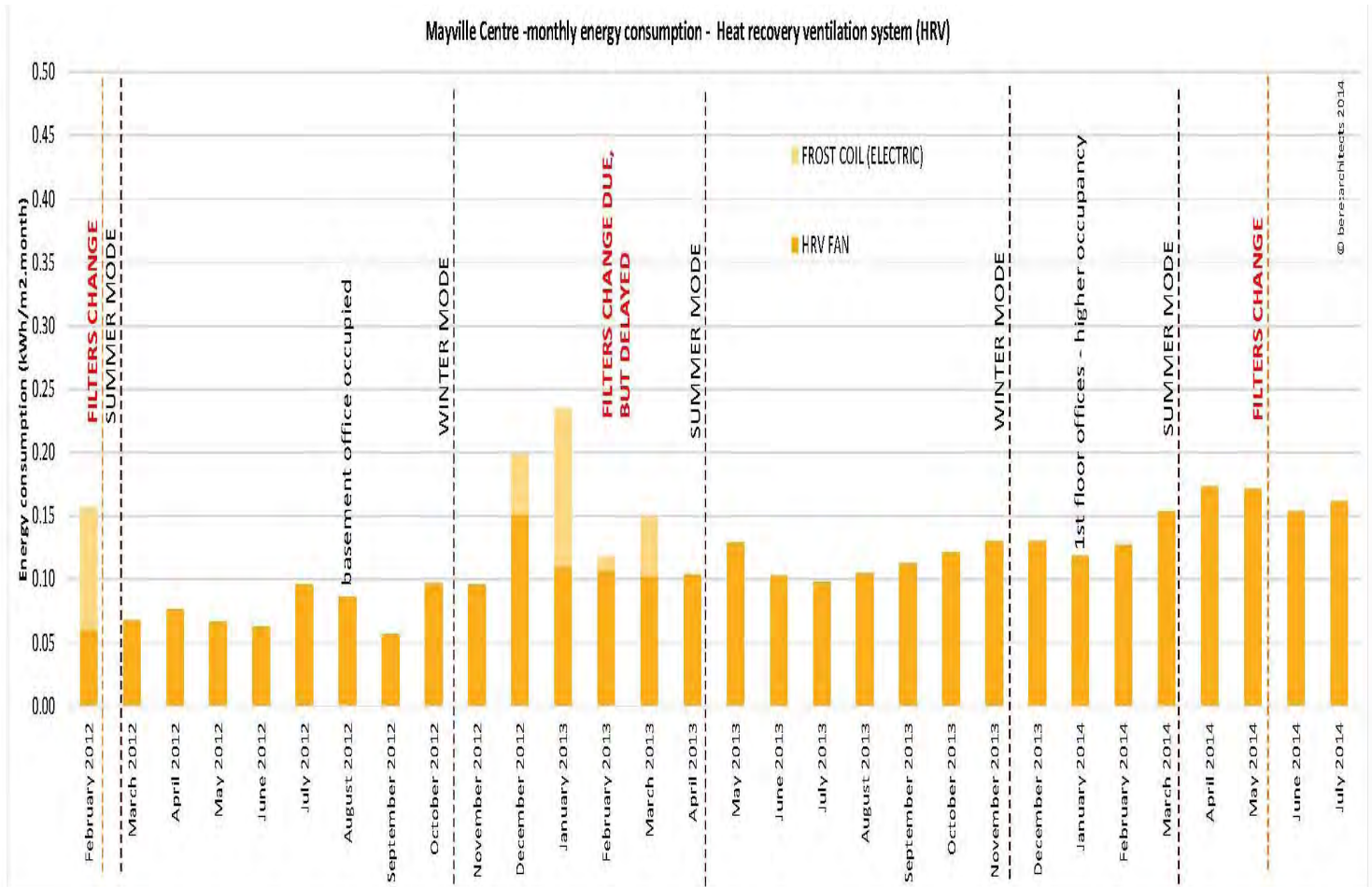

Figure 6-9 Heat recovery ventilation unit- energy consumption

The electricity consumption of the heat recovery ventilation unit was 1.66kWh/m2.year during the second year of monitoring (ending July 2014). It can be noted that after the filters were changed in 2012 the difference between the electricity used by the unit during the summer and winter months varied by maximum 0.05kWh/m2 per month. The difference was even lower between summer and winter months in 2013, although the overall consumption was higher than the previous year. This could be due to the fact that the filters had not been changed at the recommended time, but also the higher occupancy and increased use of the Centre.

This indicated to the design team that the change from summer to winter mode does not significantly increase the energy consumption, and therefore the unit could be left on full winter mode at all times.

Note: due to limited funding resources for this project, ventilation air flow rates were not checked and air flow temperatures were not measured.

6.1.3 Power consumption and generation over two years of monitoring

The following three graphs illustrate how the energy consumption of the GSHP and ventilation (shown in the above graphs) relates to the context of the building's overall energy consumption and energy production over the two years of monitoring. It is worth noting that the GSHP and ventilation systems represent a small proportion of the overall energy consumption of the building. It is also worth noting that the overall consumption of energy was slightly higher in the second year, due to a steady increase in light and socket power used across all floors.

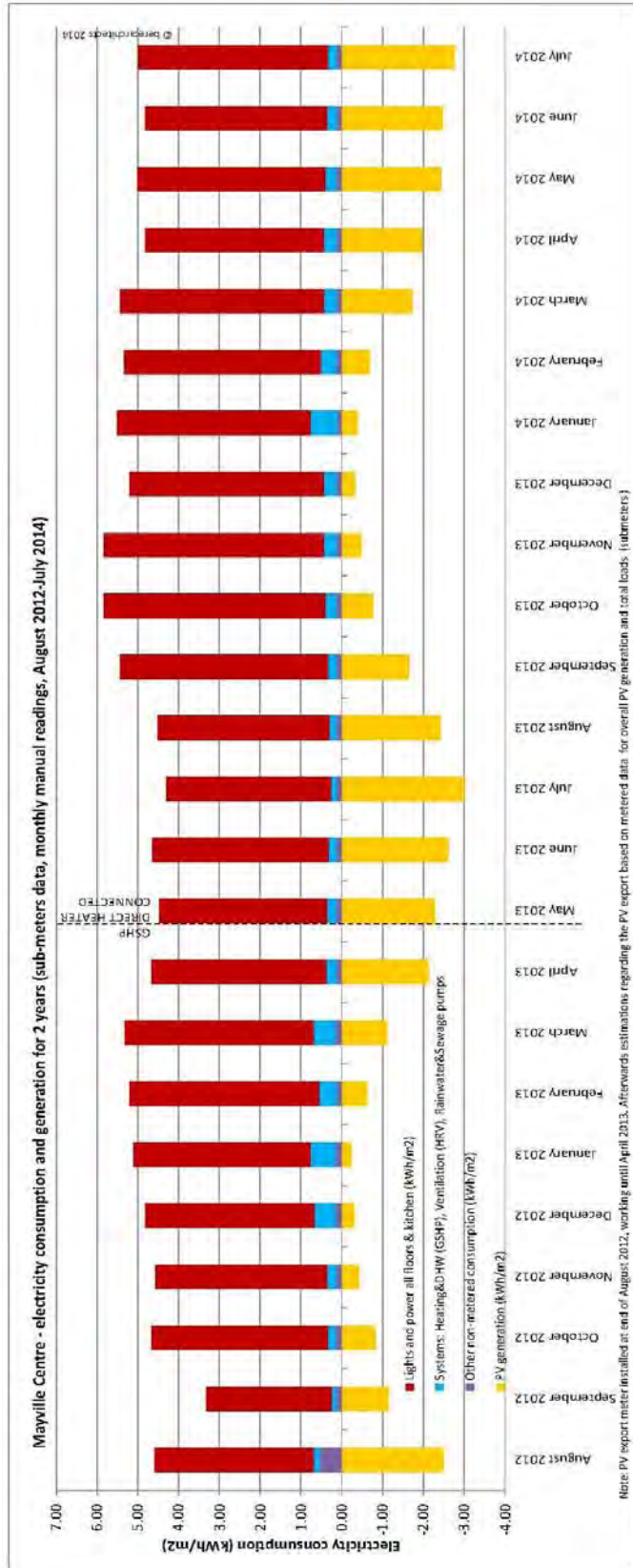

Figure 6-10 Monthly energy consumption and generation - 12 months – August 2012 –July 2014 (Slight Yr 2 increase in light and socket use, small buildings systems consumption, PV generation > building systems)

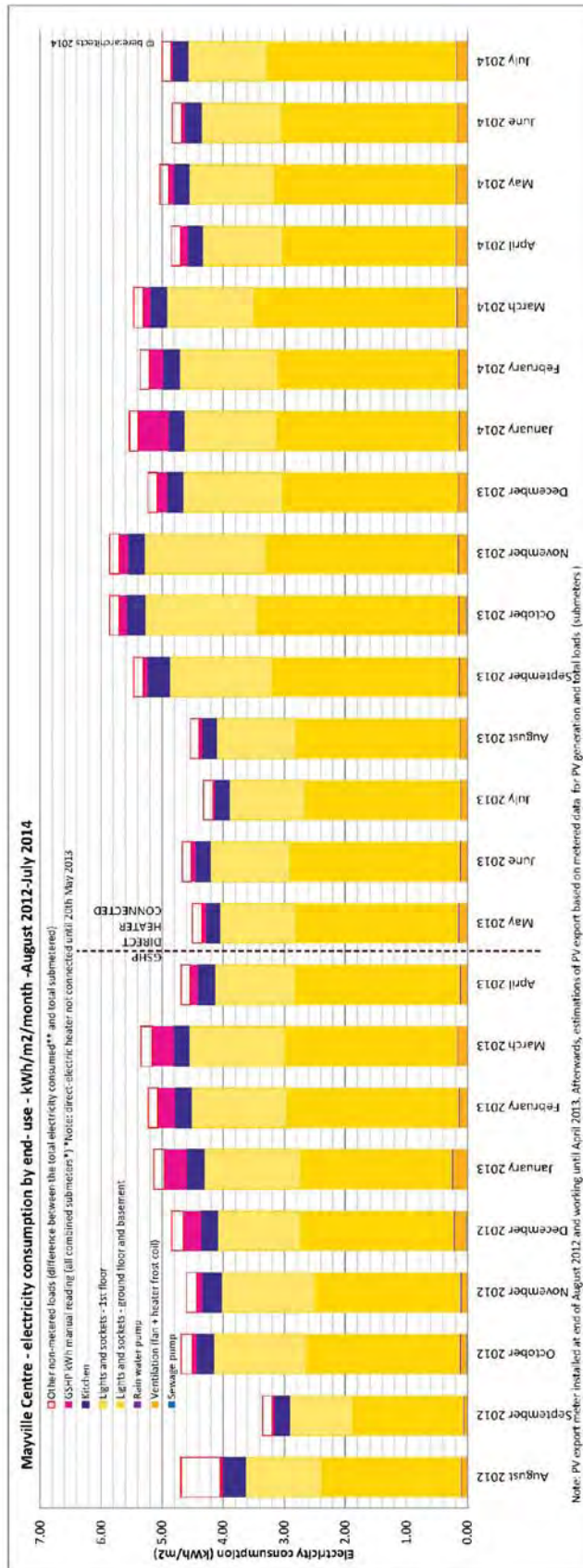

Figure 6-11 Monthly energy consumption by end use – 2 years – August 2012 –July 2014 (Yr 2 increase in lighting and sockets power across all floors attributed to increased occupancy)

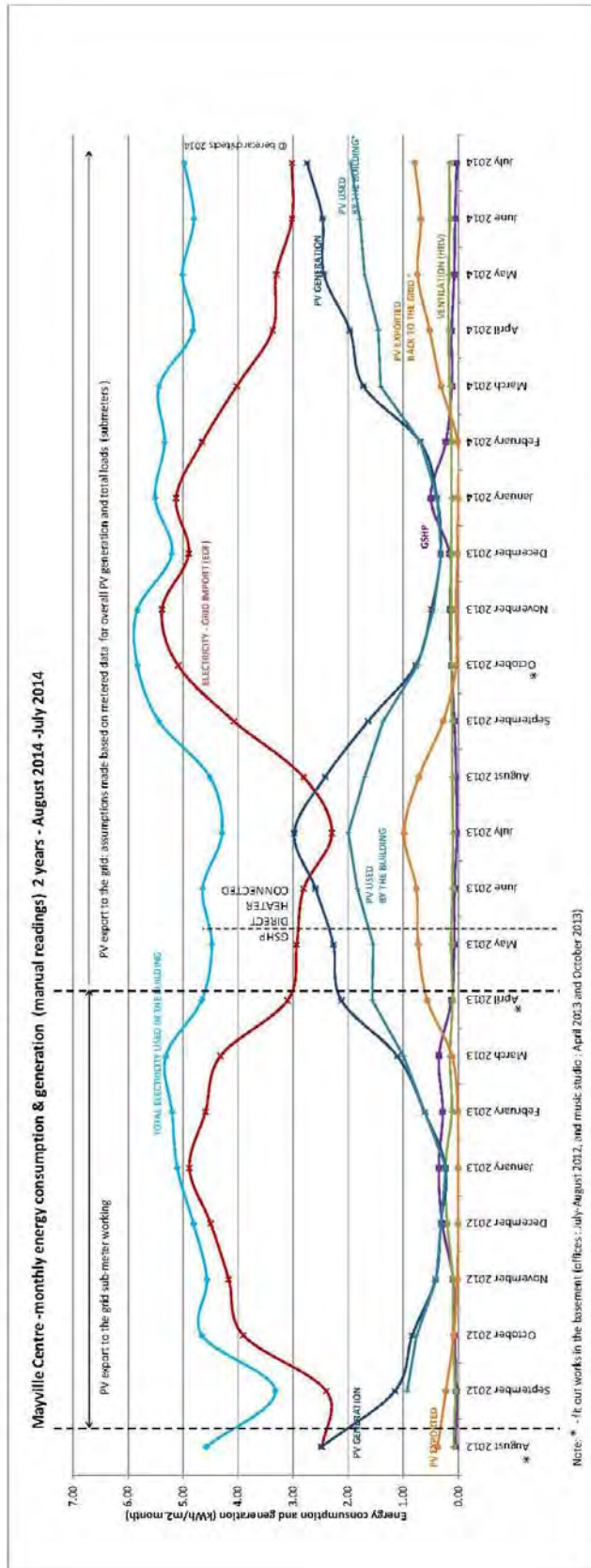

Figure 6-12 Energy consumption and generation yearly cycle – August 2012 – July 2014 (Relationship between total power use, PV generation, grid consumption, PV back to grid)

6.2 TM22 analysis

A TM22 analysis was conducted firstly by Rod Bunn of BSRIA with 12 months of monitoring data available up to July 2013, and then by bere:architects with one year's data up to December 2013 (reports attached in Appendix 10.11).

In summary, the TM22 analysis indicated that in the 12 months up to December 2013:

- The metered grid electricity consumption was 37,761 kWh per year, equivalent to 47.2 kWh/m² year. The resultant carbon dioxide emissions for the same period were 20,769 kgCO₂ per year (at the default carbon factor of 0.55 for electricity), approximately 26 kgCO₂/m² year.
- An estimated additional 10,846 kWh (13.6 kWh/m² year) were used from the total metered electricity generated by photovoltaics (PV) on site of 14,160 kWh (17.7 kWh/m² year). Due to a faulty sub-meter which was on error since April 2013, the missing PV export metered data has been calculated by extrapolating the previous trends in the building total energy consumption compared with total sub-metered data, together with other constant non-metered loads, and using the PV total generation and grid electricity metered data.
- The building used in total approximately 60.8 kWh/m².year during the 12 months up to December 2013, from the grid and the renewable electricity produced on site. The TM22 estimate based on the loads and operational profiles estimated a total of 59.2 kWh/m².year, with the following split by end-use:

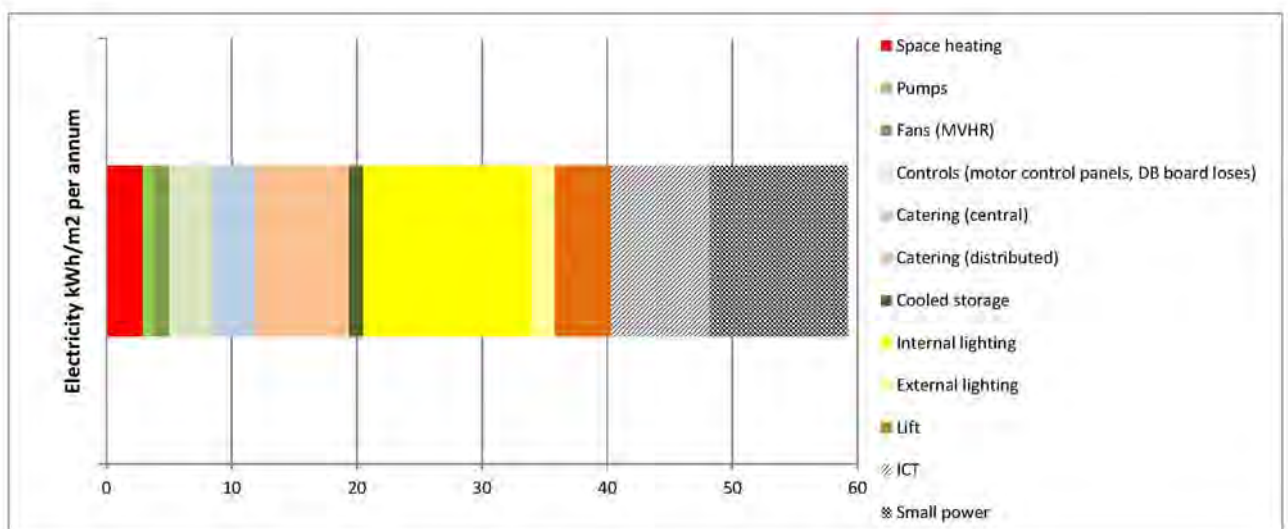

Figure 6-13 TM22 – energy use break-down

The TM22 analysis indicates that approximately 80% of the regulated use is covered by the renewable energy generated on site.

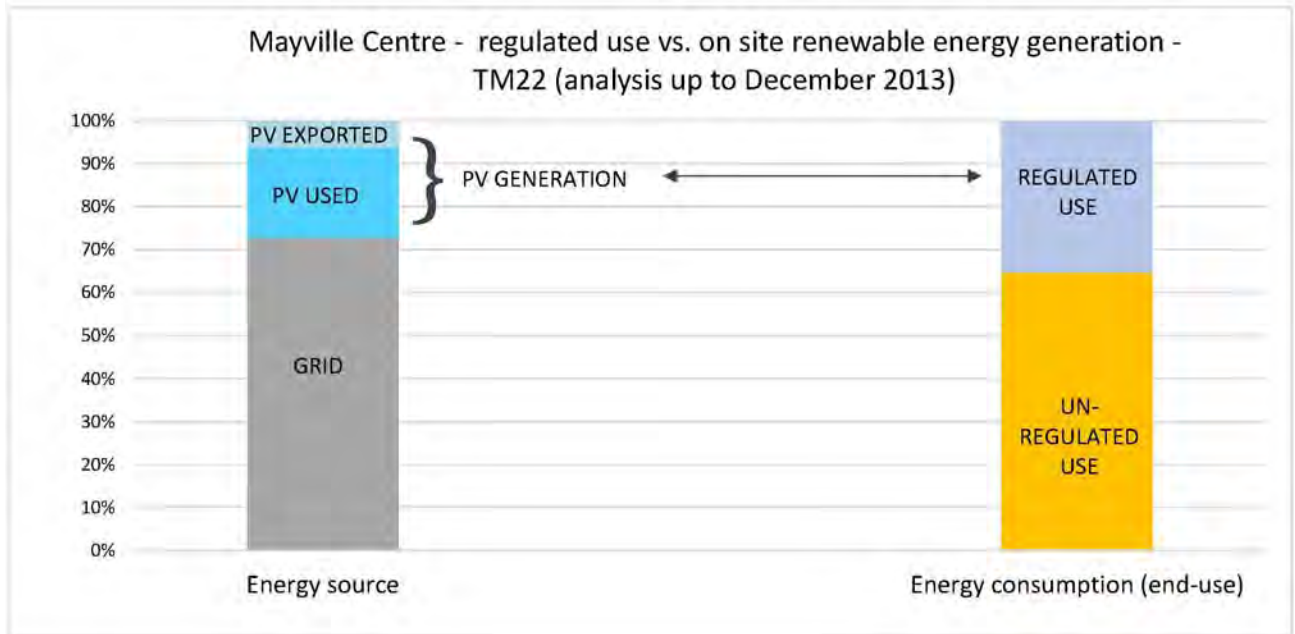

Figure 6-14 Regulated use vs. on site renewable energy generation TM22 analysis (up to December 2013)

The high unregulated energy use in the building is related to the increased occupancy, compared to the design assumptions. This was due to the fact that the rooms on the south facing basement, ground and 1st floors, assumed to be used as meeting rooms and workshops at design stage have been turned into full time offices rented to various organisations after the building was completed. The tenants added their own IT and other equipment (the building now contains 7 servers) to a larger total than was assumed beforehand, and the hours of use were extended as well. Also, the team noted that during year 2 the main hall was more frequently used than in previous years, as the Centre re-established itself in the community and neighbourhood after being closed during construction. The actual use of the building after completion meant that the energy consumed on site for small power and lighting was overall higher than assumed at design stage.

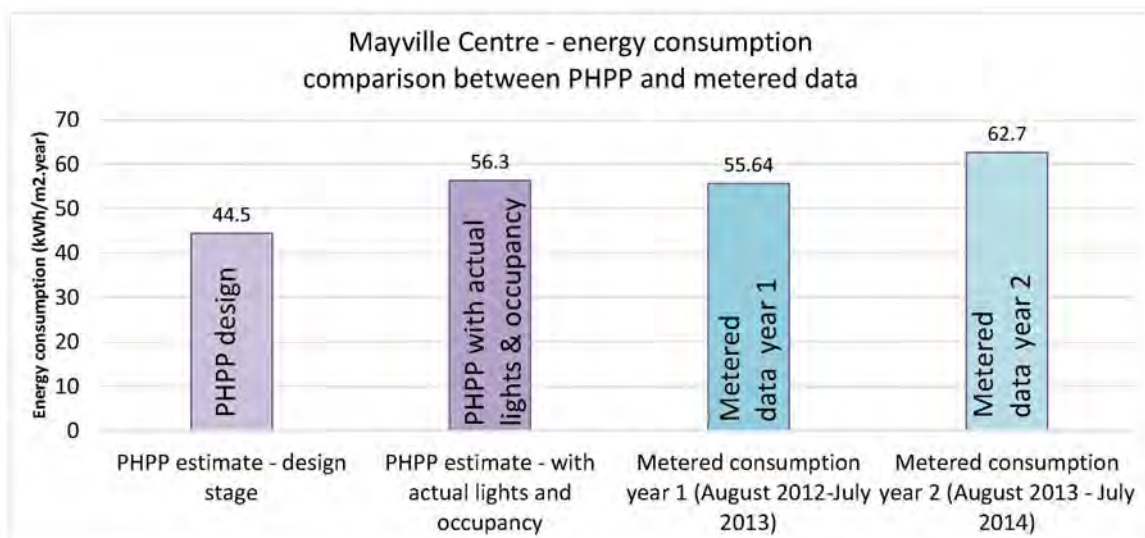

Figure 6-15 Energy consumption – comparison between PHPP and metered data

A break-down of the end uses in the building (comparing PHPP and TM22 estimation and metered data) highlighted some key findings:

- The PHPP assumptions for heating were higher than the metered data. The actual heating demand is lower than expected, due to the extra number of people and equipment providing free heat which is retained in the winter due to the draught-free construction, insulation and heat recovery ventilation.
- The increased hours of use of the main hall and offices could account for the higher consumption related to lighting & equipment in the second year of monitoring.

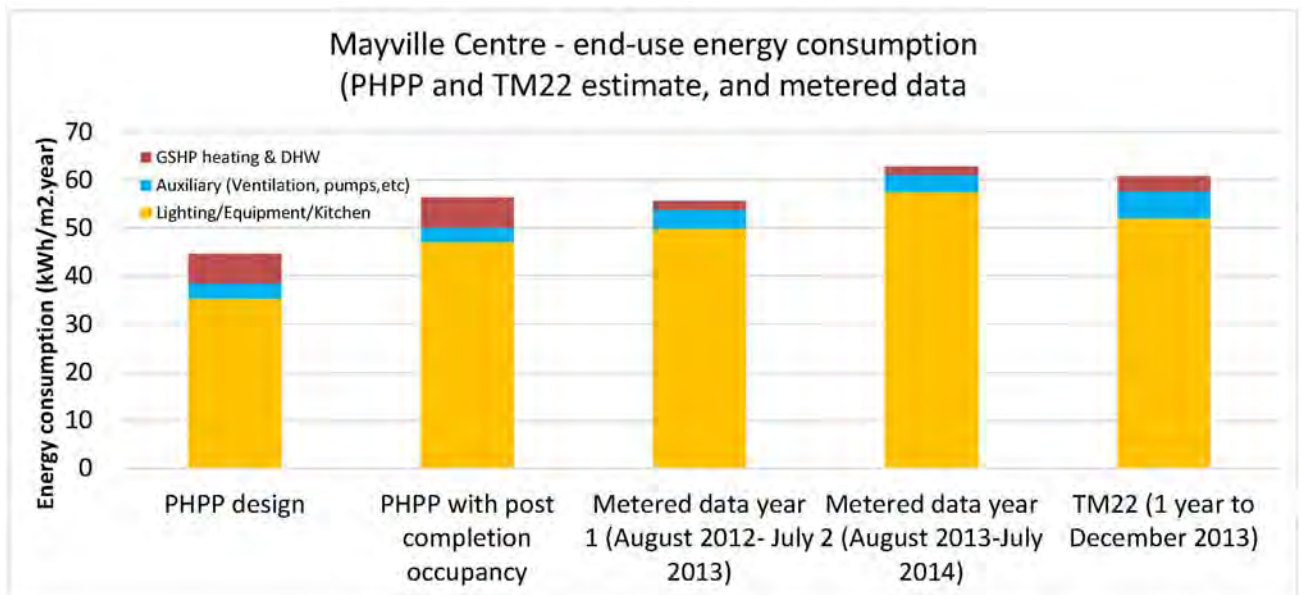

Figure 6-16 End-use energy consumption (PHPP and TM22 estimate and metered data)

6.3 CarbonBuzz

The results from the TM22 analysis were uploaded on the CarbonBuzz website. The aim of the Carbon Buzz campaign is based on the fact that *'current records often miss either design or the actual record as designers rarely have operational data and occupants rarely have design data. CarbonBuzz campaigns for the broader rollout of Display Energy Certificates to improve the feedback loop between design and operation.'*

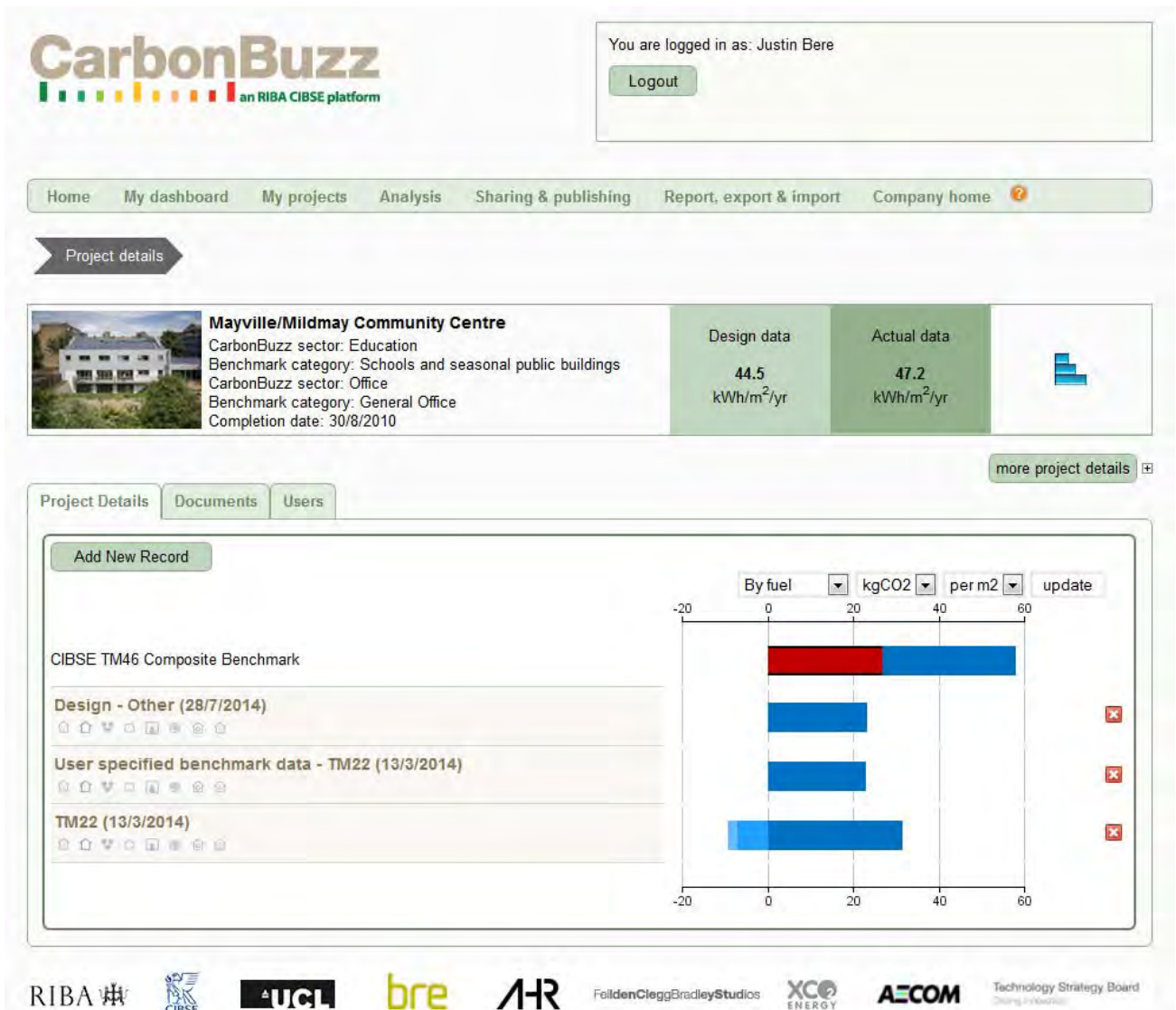

Figure 6-17 Carbon Buzz online database - The Mayville Community Centre project data

The figure below indicates that the Mayville Centre performs within the top 5% with respect to energy performance per m² of those projects uploaded onto CarbonBuzz at the time of publication. It is difficult to draw conclusions directly from this graph, since the characteristics (building type, age etc) of the other projects are not known. However, the graph does suggest that the building is a comparatively low energy building and that the energy strategy and Passive House approach adopted has resulted in a low energy building in operation.



Figure 6-18 Energy consumption – comparison of projects uploaded on the CarbonBuzz platform

6.4 Energy and bills costs savings

The design team compared the energy savings and the cost of bills, before (in 2009) and after the retrofit (Sept 2012 to Sept 2013). The energy used from the grid for after the retrofit (electricity only, all-electric building) is 85.5% lower than before the retrofit (gas and electricity), which is all the more remarkable considering the large increase in the occupancy level of the building post retrofit.

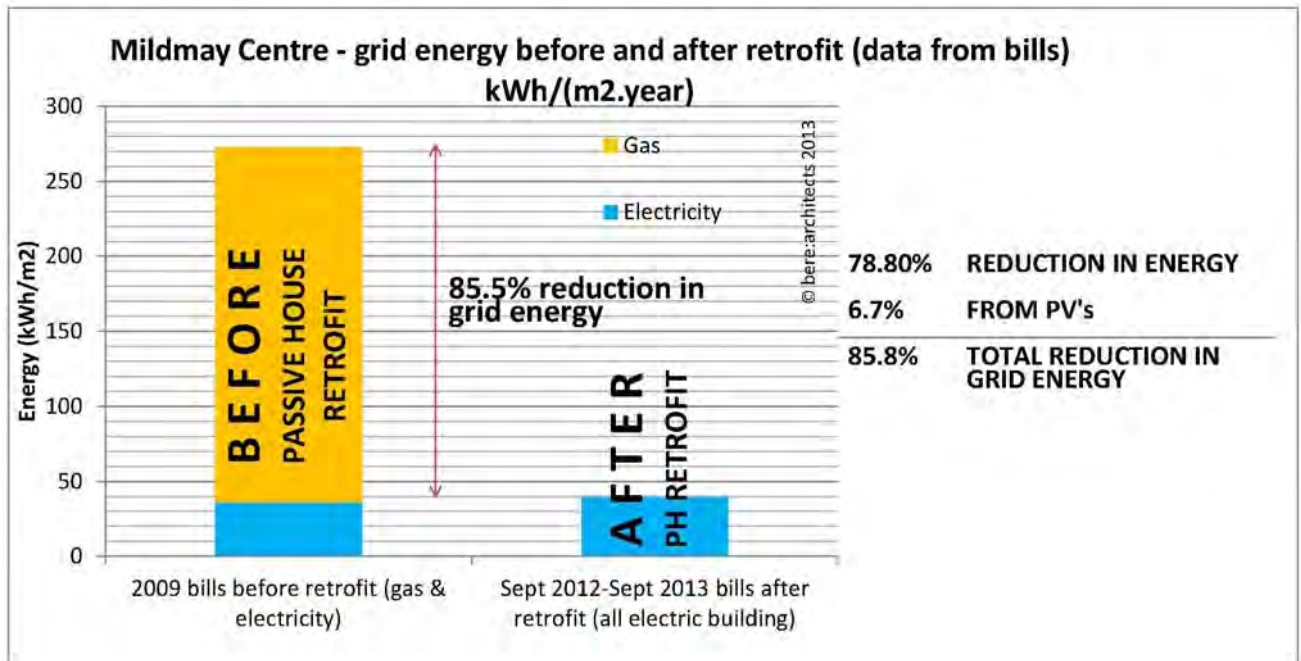

Figure 6-19 Comparison of grid energy used before and after the retrofit

The bills show a 58.5% reduction before and after retrofit, due to reduced energy consumption. An estimation of the energy used before the retrofit (kWh) in current energy costs (if the retrofit hadn't happened) shows that the current bills represent savings of 72.7%. Again this is all the more remarkable, considering the large increase in the occupancy level of the building post retrofit.

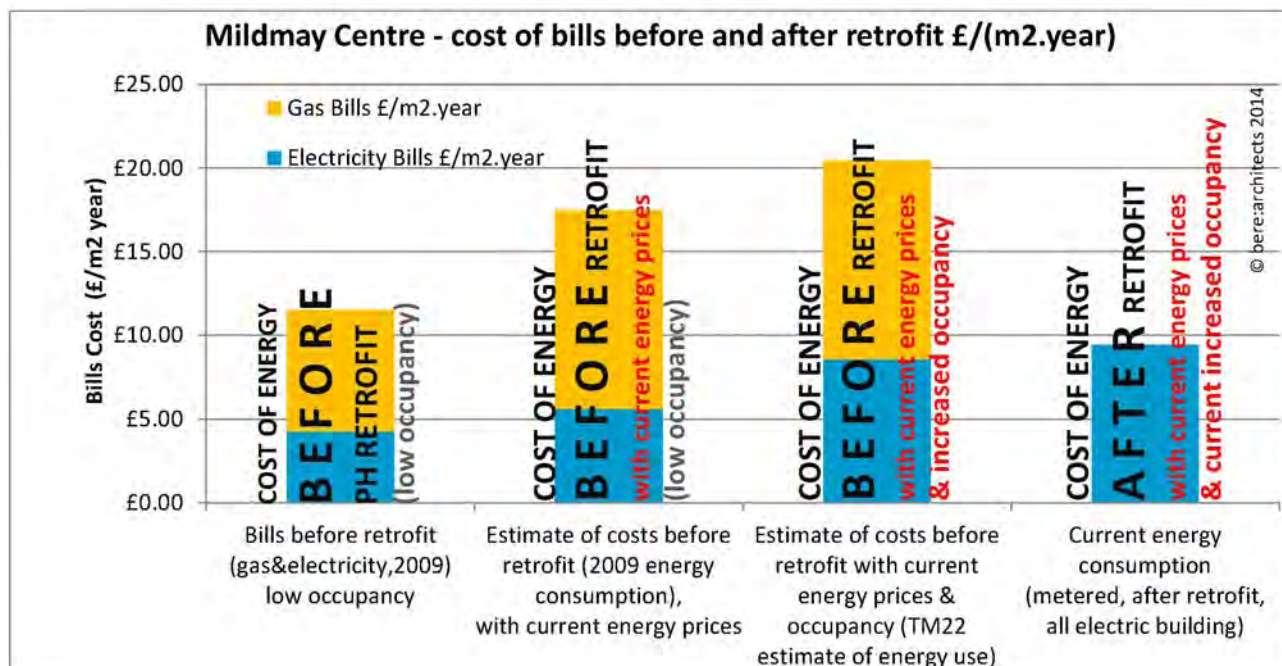

Figure 6-20 Comparison of cost of bills before and after the retrofit

6.5 Environmental conditions

6.5.1 Winter and summer strategies

As mentioned previously (see 2.3, *Building fabric and services strategy*), the building has been designed to follow two simple strategies in winter and summer, with the aim to provide comfortable conditions throughout the year, with a minimal energy use and a low impact on the environment:

During winter the aim is to recover and use the heat generated indoors by people and equipment, as well as the heat gained from the sun through the South facing glazing, and by heat recovery put into the incoming fresh air delivered by the mechanical ventilation unit. Any extra heating required, as well as the domestic hot water needed in the building is provided by the ground source heat pump.

During summer the building works in a mixed mode, the design relies on openable windows providing fresh air to most of the spaces (main hall and offices on ground floor and 1st floor), and only localised mechanical ventilation supply (basement and top floor offices), balancing the extract ventilation from bathrooms and kitchen. The strategy relies also on the use of the rooflights, particularly for purge cooling at night in conjunction with the secure opening vent at ground level in the main hall, leaving windows on tilt at night in the top floor office, and the use of external blinds set on tilt to protect from the sun's heat, but to allow daylight into the South facing rooms.

As mentioned in Chapter 2 *Details of aftercare, operation, maintenance & management* there were several items which had not been properly installed and/or commissioned, which had a temporary negative impact on the indoor conditions during the summer of 2013. The issues relating to the performance of the building and

its systems which impacted on either the comfort or the energy use are further summarised in the next chapter.

Parameter	Values	
Temperature (*C)		
Minimum	16	a
Recommended maximum	25	b
Maximum	28*	b
* no more than 1%of annual occupied hours		
Operative range	winter 19-21	b
offices	summer 22-24	b
lecture halls	summer 21-23	b
Relative humidity (%)		
Minimum	30	b
Maximum	70	b
CO2 (ppm)		
Occupied hours average	1500	c,d
Maximum	5000	a
Sources:		
a - HSE		
b - CIBSE A		
c - Approved document F		
d - Building regulations part L		

Figure 6-21 Recommended value ranges for environmental conditions (including sources of guidance)

The BPE study aimed to explore whether and how the proposed strategies work in practice, and to evaluate the main comfort parameters in the building (temperature, relative humidity and carbon dioxide concentration) by comparing the results with building regulations requirements.

The study also focused on gathering the building users' feedback. The comfort perceived by the permanent and transient occupants of the building is investigated in Chapter 4 which refers to the *Building User Surveys* (BUS).

It is relevant to note that since the sensors have been installed, the occupancy of the building increased significantly, with the architects' office moving into the basement offices (August 2012), the expanding of the electrician's offices on the 1st floor (3-4 people in 2 rooms and in January 2014 a two-person working desk on the upper landing facing the main hall), the music studio fit-out completed (April –May and then October 2013) and subsequent occupancy, and the increase in hiring of the main hall for both regular activities and other occasional events.

6.5.2 Monitored indoor comfort conditions

6.5.2.1 Findings and comparison between the two years

During the 2 years analysed (August 2012 – July 2014), the team monitored and analysed the indoor and outdoor temperatures, relative humidity and carbon dioxide concentration.

The monthly average temperatures and relative humidity during occupied hours indicate good comfort levels, steady temperatures and relative humidity levels.

**Mayville Centre - monthly average temperatures (°C) during occupied hours
June 2012- July 2014**

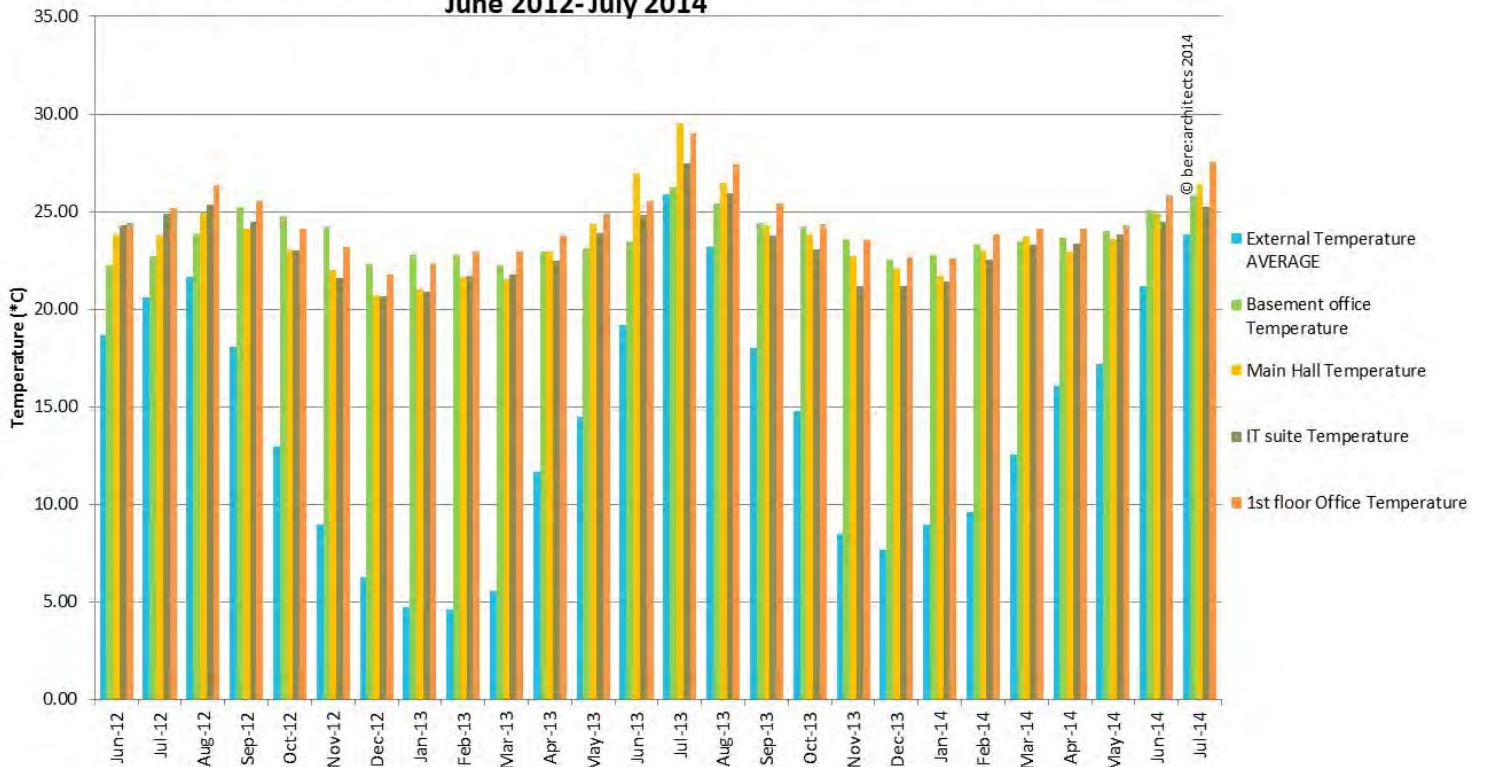

Figure 6-22 Monthly average temperatures during occupied hours

**Mayville Centre - monthly average relative humidity (%) during occupied hours
June 2012- July 2014**

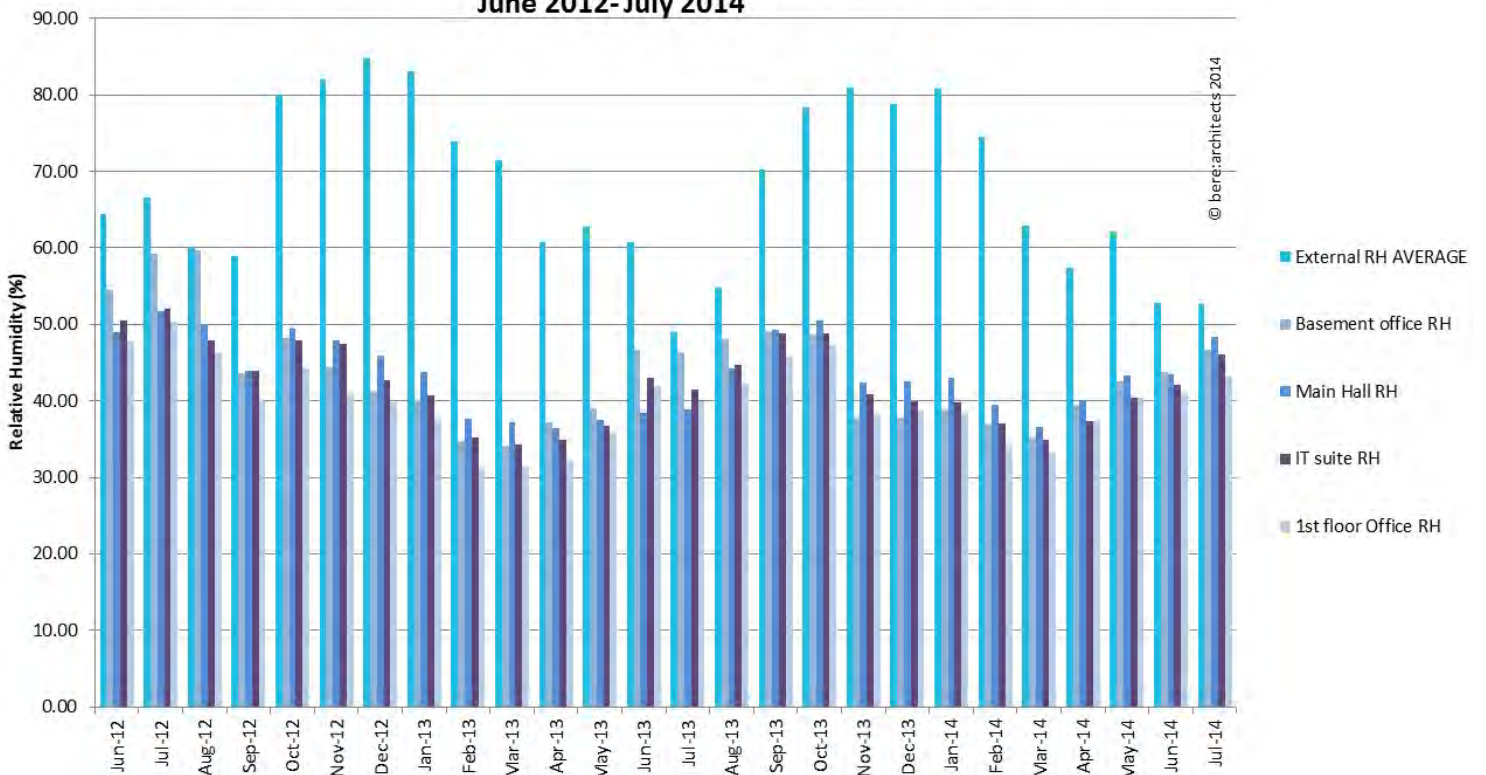

Figure 6-23 Monthly average relative humidity during occupied hours

The team also investigated the maximum, minimum and average monthly temperatures, relative humidity and CO2 concentration during the occupied hours, highlighting the values as well as the percentage of time the parameters were outside the recommended range:

		Temperature (*C) during occupied hours					Relative humidity (%) during occupied hours					CO2 (ppm) during occupied hours	
		Basement office	Main Hall	IT suite	1st floor office	External	Basement office	Main Hall	IT suite	1st floor office	External	Main Hall	IT suite
August 2013**	AVG	25.44	26.45	25.92	27.42	23.17	48.14	44.23	44.63	42.33	54.80	427.32	405.11
	MAX	28.60	32.50	28.60	29.70	34.26	59.76	67.88	59.80	57.36	85.80	903.19	856.94
	MIN	24.10	24.10	24.25	25.70	16.00	38.30	28.90	30.60	28.83	35.07	365.62	368.15
September 2013**	AVG	24.44	24.29	23.77	25.41	17.99	49.09	49.25	48.80	45.70	70.19	512.69	443.22
	MAX	28.10	27.00	26.80	30.50	30.35	61.73	67.95	62.70	64.93	91.32	1714.73	822.46
	MIN	22.86	21.90	20.35	22.66	11.29	38.01	32.25	34.73	30.27	43.85	376.62	378.40
October 2013	AVG	24.23	23.82	23.07	24.33	14.77	48.71	50.47	48.78	47.35	78.40	582.67	468.70
	MAX	25.37	25.10	24.50	26.30	20.87	57.80	65.19	61.50	60.51	91.30	1077.91	782.60
	MIN	22.40	21.53	21.33	20.87	6.67	37.50	32.26	33.00	30.43	58.02	395.60	389.29
November 2013	AVG	23.61	22.71	21.20	23.55	8.51	37.89	42.43	40.84	38.05	80.90	593.13	531.20
	MAX	25.10	24.40	22.80	25.20	14.40	48.30	61.99	57.89	50.44	90.40	1634.00	896.46
	MIN	21.10	20.70	18.43	20.92	1.87	31.80	32.20	29.17	27.43	63.01	385.39	410.65
December 2013	AVG	22.55	22.05	21.20	22.64	7.64	37.80	42.50	39.99	38.76	78.88	641.21	510.62
	MAX	25.10	23.90	22.90	24.67	12.90	47.20	53.84	51.96	49.22	93.37	1517.21	1018.94
	MIN	20.11	20.20	16.78	19.00	1.15	31.10	34.05	31.60	27.19	49.81	384.85	387.08
January 2014	AVG	22.76	21.74	21.45	22.57	8.99	38.93	43.04	39.84	38.48	80.87	648.06	533.90
	MAX	24.70	23.18	23.00	25.10	12.70	45.70	52.97	50.30	49.59	92.92	1084.43	1148.27
	MIN	20.00	19.60	20.00	20.30	4.85	34.40	32.79	31.94	27.43	62.77	380.17	381.75
February 2014	AVG	23.33	22.99	22.55	23.84	9.61	36.89	39.45	36.98	34.14	74.48	677.36	564.79
	MAX	24.80	24.40	24.29	25.70	14.67	42.40	50.55	47.20	43.07	93.00	1412.42	1378.15
	MIN	21.40	22.00	21.70	22.24	4.95	31.61	28.24	28.60	23.05	47.07	417.93	395.56
March 2014	AVG	23.50	23.71	23.30	24.11	12.56	35.24	36.54	34.85	33.27	62.91	616.43	538.18
	MAX	24.90	25.10	24.49	25.77	18.50	38.70	49.20	48.16	41.73	90.02	1364.33	1678.00
	MIN	21.50	20.60	22.00	21.48	4.08	30.80	25.50	24.71	22.78	35.84	401.40	387.00
April 2014	AVG	23.65	22.98	23.33	24.10	16.06	39.49	40.04	37.33	37.42	57.44	548.37	439.24
	MAX	25.00	26.00	24.66	26.85	20.65	45.90	54.65	48.90	50.50	91.75	1731.23	731.00
	MIN	21.10	18.60	22.00	21.40	10.08	30.42	25.65	26.20	23.50	32.40	395.60	389.15
May 2014	AVG	24.02	23.60	23.85	24.31	17.19	42.58	43.26	40.43	40.43	62.10	549.84	453.34
	MAX	25.36	26.50	25.70	26.70	26.60	47.40	75.09	52.35	54.69	92.41	2199.45	908.07
	MIN	21.90	21.00	22.56	22.50	10.67	37.56	28.72	31.12	27.82	35.21	376.25	378.40
June 2014	AVG	25.04	24.86	24.46	25.81	21.19	43.77	43.45	42.10	41.01	52.82	467.24	435.70
	MAX	26.40	27.18	26.40	28.57	26.50	51.94	60.50	53.42	54.40	89.22	969.17	1058.65
	MIN	23.11	22.33	21.60	22.60	14.06	38.64	29.14	33.42	30.40	36.31	377.28	378.67
July 2014	AVG	25.85	26.40	25.22	27.55	23.86	46.66	48.40	46.10	43.14	52.68	463.67	412.63
	MAX	29.00	29.60	27.30	30.15	31.42	57.24	67.26	64.14	58.50	88.06	1750.10	597.70
	MIN	23.30	23.00	21.90	24.40	14.83	38.51	32.15	32.04	31.96	28.95	366.87	370.06

August 2013 - July 2014 Year 2 Percentages of time the temperature, RH or CO2 values are outside the recommended ranges, out of the total occupied hours:

Temperature (*C)					Relative humidity (%)					CO2 (ppm)	
Basement office	Main Hall *	IT suite	1st floor office	Kitchen	Basement office	Main Hall	IT suite	1st floor office	Kitchen	Main Hall	IT suite
0.54%	2.12%	0.22%	7.25%	0.19%	0.00%	1.40%	2.88%	4.37%	0.19%	0.28%	0.11%

** Rainsensors not connected on the main hall rooflights by the main contractor, consequently the rooflights were kept shut most of the time during summer.

Figure 6-24 Maximum, minimum and average temperatures, relative humidity and CO2 concentration during occupied hours

Winter: The data recorded during the first and second monitored winters (2012-2013 and 2013-2014) indicates very constant internal temperatures (between 20-25C) regardless of the fluctuations in the external temperature, and healthy levels of internal relative humidity, between 30-70%:

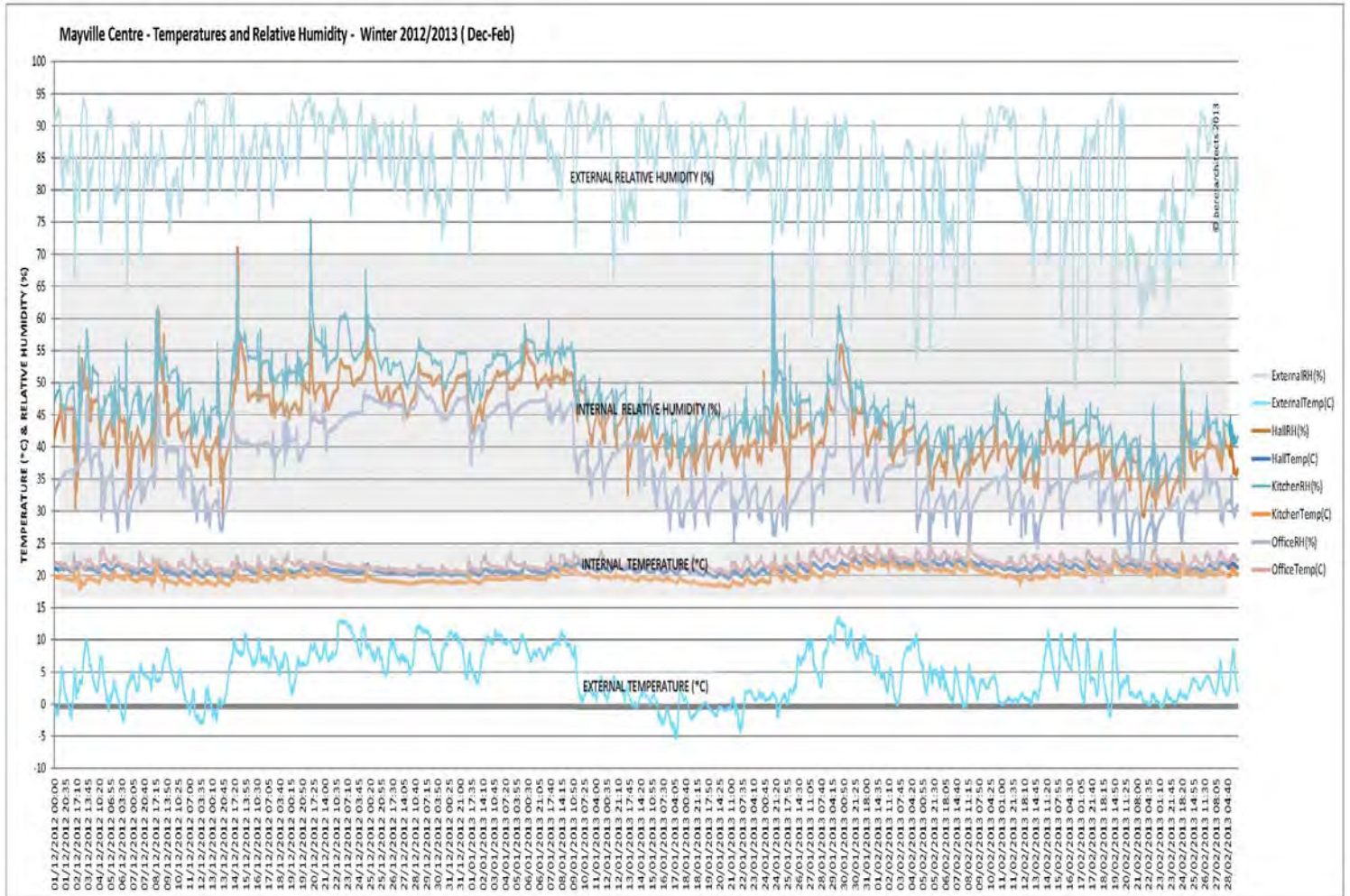

Figure 6-25 Temperatures and relative humidity – Winter 2012 / 2013

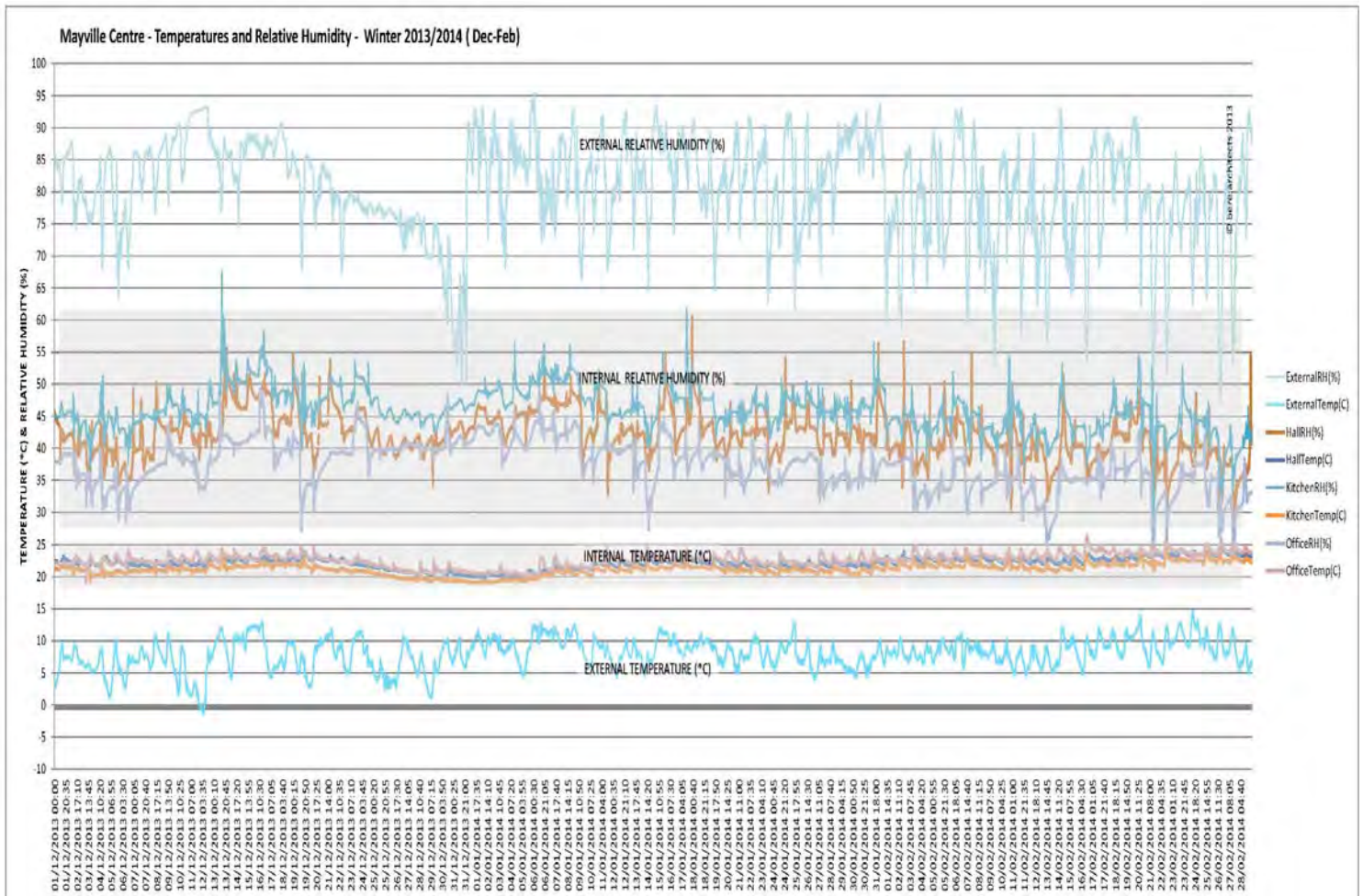

Figure 6-26 Temperatures and relative humidity – Winter 2013 / 2014

Summer: During the summer, when the building is used in a mixed-mode strategy, the temperatures indoors follow the fluctuations of external temperatures. During the first summer the cooling strategy was not properly implemented (the rainsensors on the rooflights had not been connected by the contractor so night purging was not used, and the use of blinds was not very effective, as described in Chapters 3 and 5). This reflected in higher indoor temperatures during very hot days in that year.

A client workshop was organised in the first summer and the team noted the building occupants were not really aware of how to use the blinds in an effective manner, or that they could use night time ventilation to cool their offices by leaving the windows on tilt. Since the rain sensors had not been connected to the rooflights in the main hall, the managers of the Centre were reluctant to leave the roof windows open for fear rain would damage the hall.

Therefore there was very little opportunity to use the main summer ventilation and cooling strategies envisioned during design stage: night purging (as a note, this is a widely used strategy for summer cooling currently used in most low energy designs).

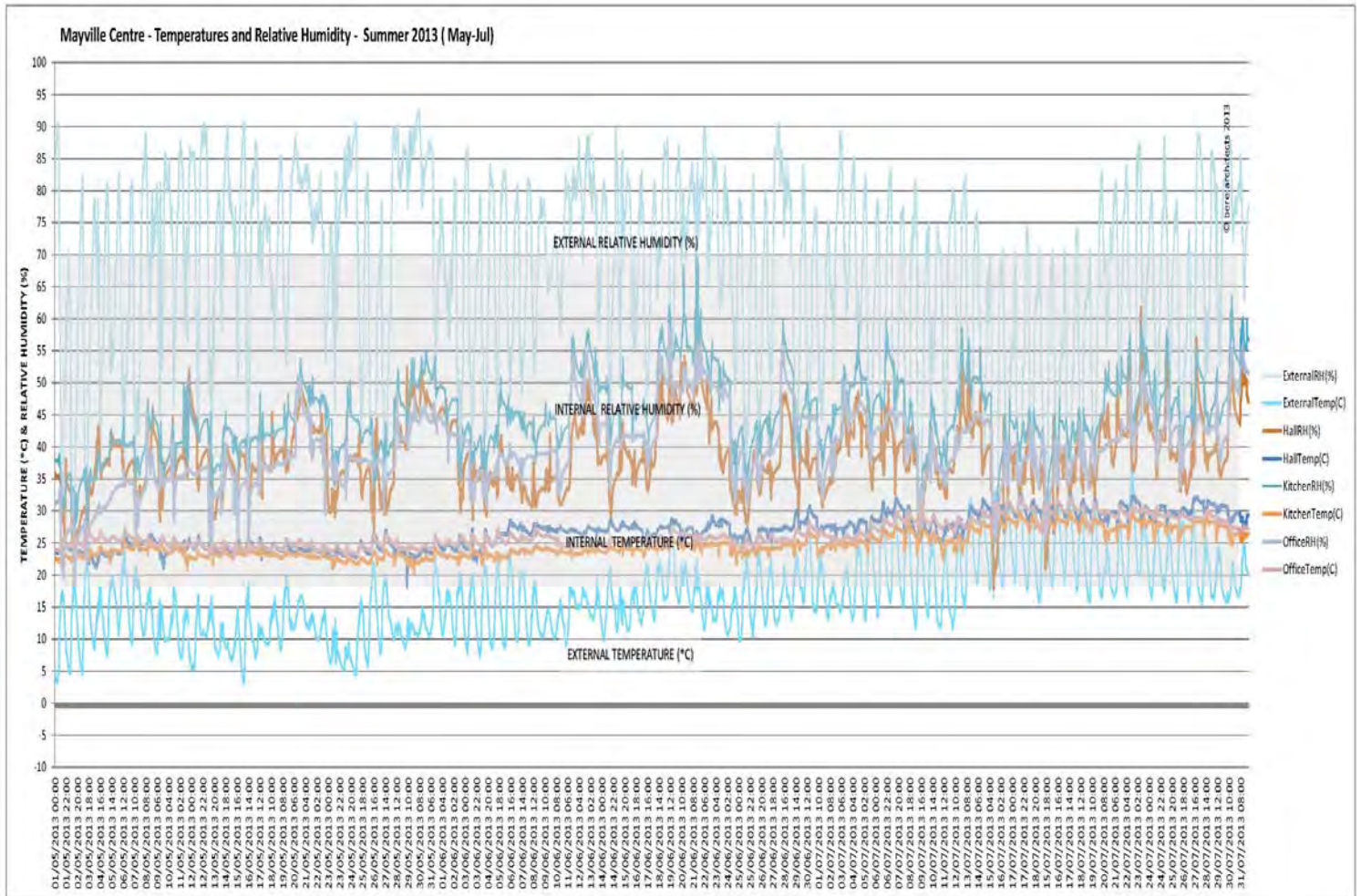

Figure 6-27 Temperatures and relative humidity – Summer 2013

The analysis of a day in August 2013 showed how the lack of purge ventilation through the rooflights and other factors impacted on the temperatures indoors:

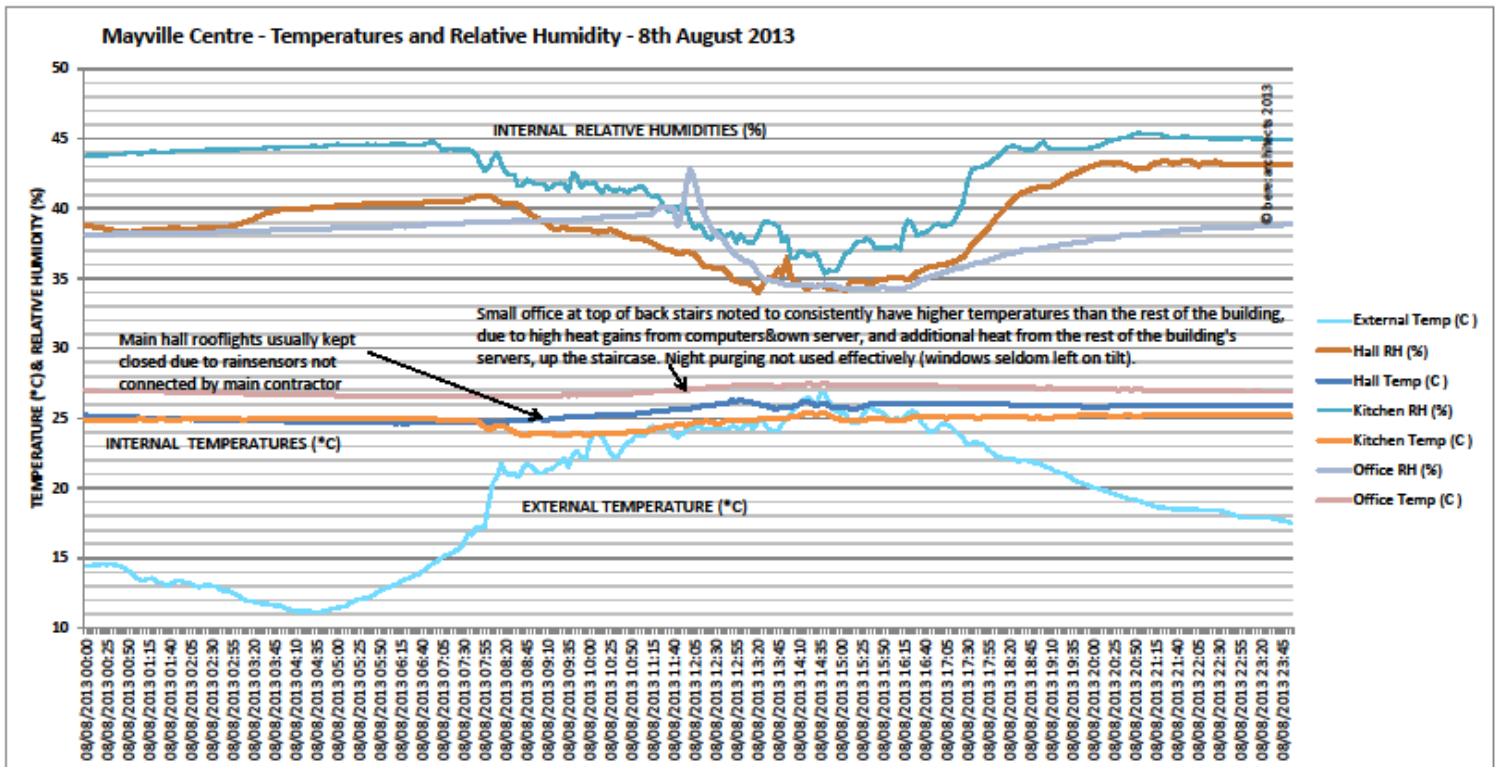

Figure 6-28 Temperatures and relative humidity – 8th August 2013

The occupants in the first floor office at the end of the main hall (which is used approx. 3 days per week) reported high temperatures at times. The team investigated the causes and found that while that office receives solar gains through the fixed window that the office has towards the main hall, it also has high internal gains due to high occupancy and a concentration of office equipment (3 computers and screens, printer, server, microwave, small fridge within the small office space, and heat rising from two servers at the foot of the staircase that it opens on to). The two servers belonging to the Centre’s management are located in a small unventilated room in the basement at the bottom of the staircase, which was kept with the door open at all times. The heated air rises up through the staircase to the top floor office, where the occupants used to leave the door open.

The team explained to the occupants and the Centre managers that a significant improvement in their comfort during the summer would be achieved by using night ventilation leaving the windows on tilt, and that a cloud solution to replace the many servers in the building would be advisable. The occupants started to leave the windows on tilt, and the team reminded them again during the second summer that this strategy was effective in providing good levels of comfort during the summer months.

After the workshop with the building occupants in the first summer the team decided to relocate one of the sensors from the ground floor office to the 1st (top) floor office located on the West staircase.

During the second summer (2014, which was warmer than 2013) the rainsensors were operational (they had been connected in October 2013), and the Centre’s managers confidently used the rooflights for purge ventilation, cooling the building over night and early morning. Summer temperatures were dramatically improved in 2014.

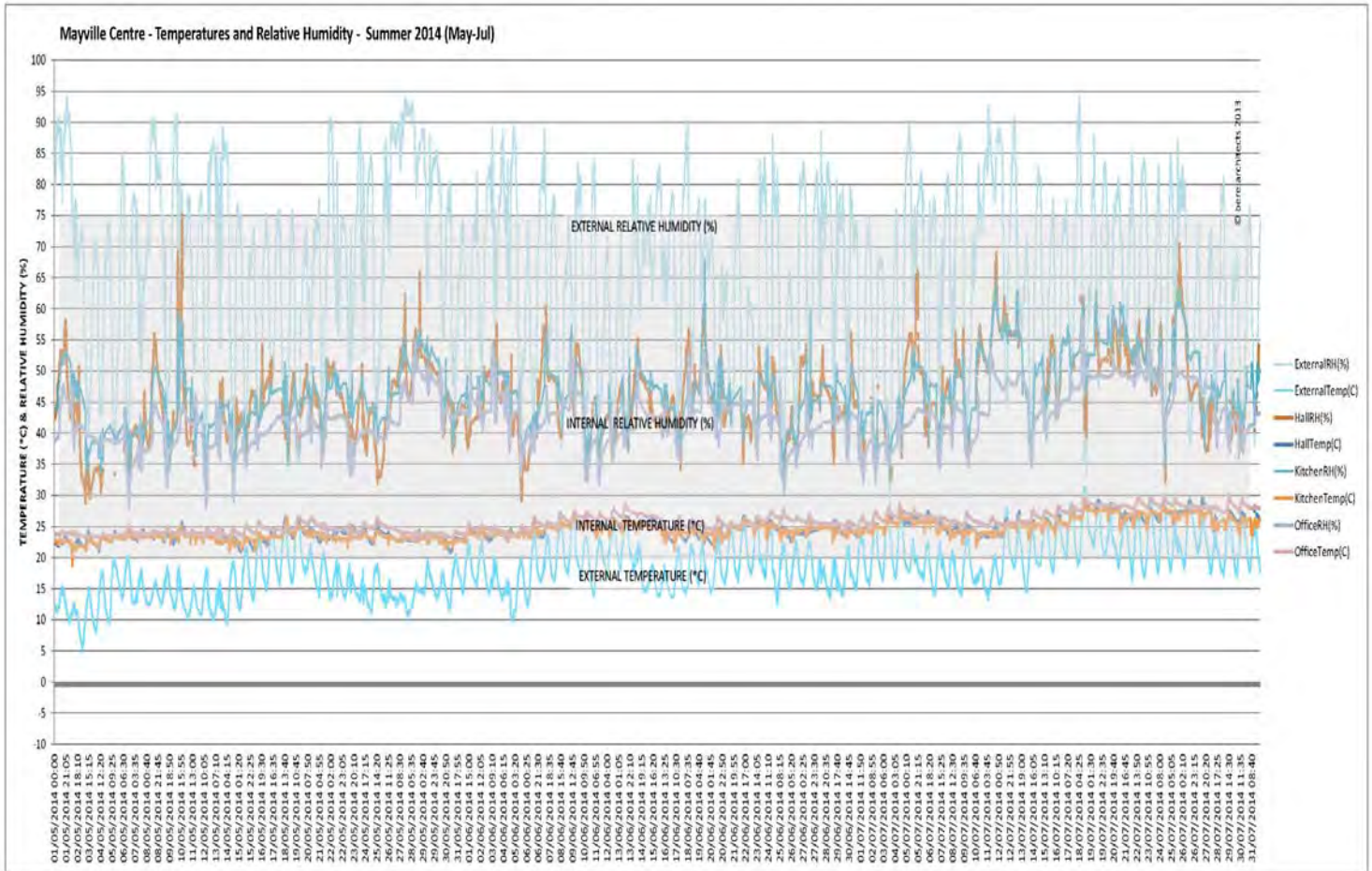

Figure 6-29 Temperatures and relative humidity – Summer 2014

A detailed analysis of the % of occupied hours when the environmental parameters were outside of the recommended range showed a large difference in indoor conditions between the 2 years:

August 2012-July 2013	Year 1	Percentages of time the temperature, RH or CO2 values are outside the recommended ranges, out of the total occupied hours:											
		Temperature (*C)					Relative humidity (%)					CO2 (ppm)	
		Basement office	Main Hall *	IT suite	1st floor office	Kitchen	Basement office	Main Hall	IT suite	1st floor office	Kitchen	Main Hall	IT suite
		1.47%	9.05%	4.79%	7.73%	3.40%	4.15%	3.39%	7.13%	14.44%	0.77%	0.38%	1.22%
		* Occupied hours for the main hall are very difficult to determine, due to the various times when bookings are made in the hall on a weekly basis. However, there is a constant use during the weekend days for several churches' events, and a 10:00-20:00 occupied hours during working days were assumed in the analysis, although this might be slightly too extensive compared to the actual use of the hall.											

Figure 6-30 Percentage of time temperature, RH or CO2 are outside the recommended range, year 1

August 2013-July 2014	Year 2	Percentages of time the temperature, RH or CO2 values are outside the recommended ranges, out of the total occupied hours:											
		Temperature (*C)					Relative humidity (%)					CO2 (ppm)	
		Basement office	Main Hall *	IT suite	1st floor office	Kitchen	Basement office	Main Hall	IT suite	1st floor office	Kitchen	Main Hall	IT suite
		0.54%	2.12%	0.22%	7.25%	0.19%	0.00%	1.40%	2.88%	4.37%	0.19%	0.28%	0.11%

Figure 6-31 Percentage of time temperature, RH or CO2 are outside the recommended range, year 2

A significant improvement was found in indoor conditions in the second summer after the designed summer cooling strategies were operational and the users became used to controlling their environment using

openable windows and external blinds. The low-energy strategy did not permit air conditioning, and by 2014 users were familiar with the passive cooling system which appeared to be working for them.

The ventilation for the 20sqm 1st floor office at the top of the stairs could be further improved by leaving the windows on tilt during the night and by reducing the equipment used in such a confined space (3 computers and screens, server, printer, microwave, fridge and kettle).

6.5.2.2 Climatic changes, internal comfort and design decisions

The MetOffice weather data³ mentions that the **summer 2013** 'was the warmest summer in the UK since 2006, but not exceptionally so, with a mean temperature of 15.2 °C, which is 0.8 °C above the long-term average. June was the only relatively cool month at 0.2 °C below the long-term average, July was 1.9 °C above, and August was 0.7 °C above. The most notable weather of the summer was a prolonged heat wave from 3 to 22 July, when high pressure was established across the UK, bringing fine, warm, sunny weather. Summer overall for the UK was drier than the long-term average with 78%'.

However, in **summer 2014**, 'mean temperatures were above the long-term average for both June and July (each month anomaly +1.2 °C); these months were provisionally equal-9th and equal-8th warmest respectively in UK series from 1910. July was the eighth consecutive warmer than average month for the UK.'

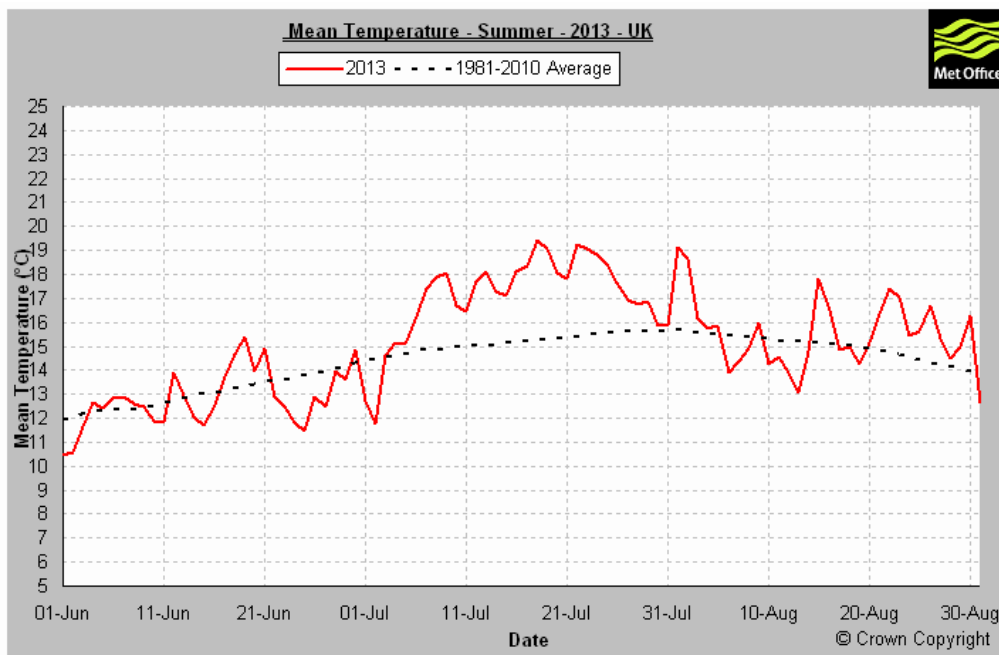

Figure 6-32 Mean summer temperatures in UK, 2013 and 1981-2010 average (source: MetOffice data)

As the monitoring data indicated, the relatively high outdoor and indoor temperatures during the second summer (2013) showed that it is paramount that the summer ventilation strategies proposed at design stage are working in practice, especially in the main hall and the 1st floor office at the top of the West staircase.

³ Data from the MetOffice website, accessed here: <http://www.metoffice.gov.uk/climate/uk/summaries>

Although all the windows are openable and allow for natural ventilation and direct occupant control, an important part of the summer ventilation strategy includes the use of blinds on the large south facing windows, and the use of the main hall rooflights for stack ventilation and night purging.

Unfortunately, the fact that the rain sensors were not installed by the main contractor meant that the rooflights were rarely used by the managers of the Centre until they were fixed in 2014, in case of potential damage to the main hall if the rooflights remained open during rain. Also, the use of blinds was not as efficient as assumed during design stage: on the ground floor offices and dining area the large floor- to-ceiling doors are usually left wide open towards the external walkway/balcony and terrace allowing access to the communal garden, therefore the blinds were usually kept up during most of the day. The use of the blinds was modelled in PHPP at design stage to check that moveable external shading would limit excessive heat gains during the summer.

The **winter** of 2013 had a 'mean temperature over the UK for winter was 3.3 °C which is 0.4 °C below the long term average(...). Winter overall for the UK was marginally wetter than the long term average with 106%, although much of Highland Scotland was drier than average. It was the wettest December since 1999 with 149% of long term average rain⁴.

The analysis indicated that the building performed very well during the winter, regardless of the challenging and extremely fluctuating weather conditions.

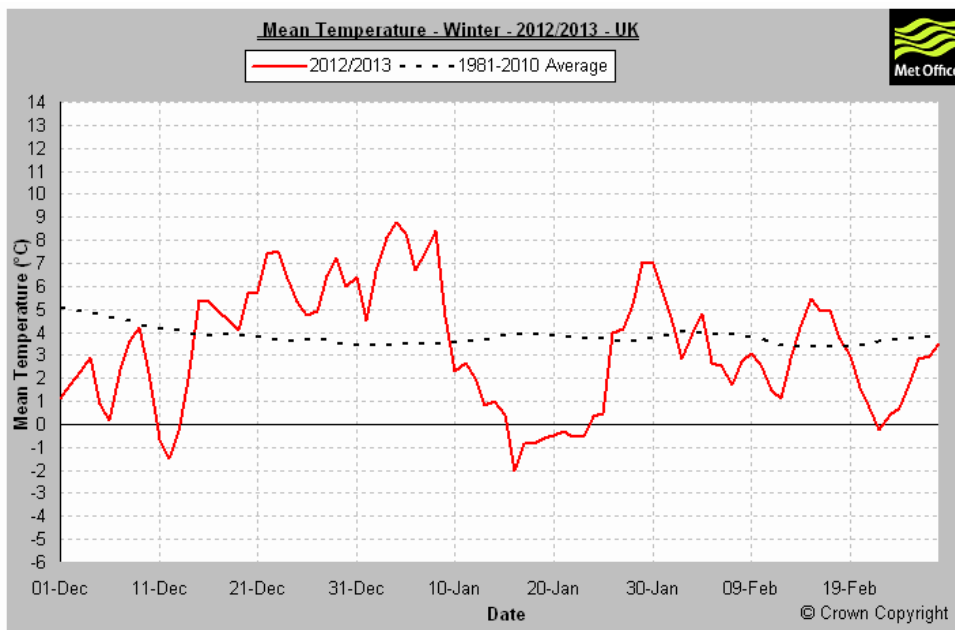

Figure 6-33 Mean winter temperatures in UK, 2012/2013 and 1981-2010 average (source: MetOffice data)

The design team found that while in the winter the fabric-first approach ensures a high indoor comfort with extremely low energy consumption, meeting the requirements of the Passive House standard with little

⁴ MetOffice, 2013, <http://www.metoffice.gov.uk/climate/uk/summaries/2013/winter>

occupant effort, designers need to carefully implement passive cooling strategies for summer months and occupants need to pay attention to using the design cooling strategies in hot summer weather.

In order to maintain an overall comfortable environment, the occupants need to interact more with the building in the summer (operating the blinds and the openable windows) than during the winter when the comfortable temperatures are achieved without any other effort than occasionally a thermostat.

The design team learned that is important to provide varied, user friendly summer ventilation strategies (and check they are implemented on site) which ensure occupant control while providing effective protection against high external temperatures. This will become even more important in the near future, since studies regarding the London urban heat island are exploring '*the benefits (e.g. decrease in space heating demand in winter) and disbenefits (e.g. increase in space cooling demand in summer) resulting from heat island effects*⁵.

The team found that the manager of the Centre became proficient in operating the main hall rooflights once the rain sensors started working in time for the summer of 2014.

6.5.2.3 Main hall

A comparison between the temperatures inside the main hall between the two summers clearly shows that, even though the second summer was similar or even warmer, the summer temperatures in the main hall were lower by 3-4C in 2014 compared to summer 2013. This indicates that the cooling of the building has improved significantly. This is also supported by the analysis regarding the percentage of time when the temperature, RH and CO2 levels were outside the recommended range, as shown above. This has been also noted by the occupants, as explained in Chapter 4 'Key findings from occupant surveys'.

⁵ Mavrogianni, Davies, 2011, accessed here: <http://bse.sagepub.com/content/32/1/35>

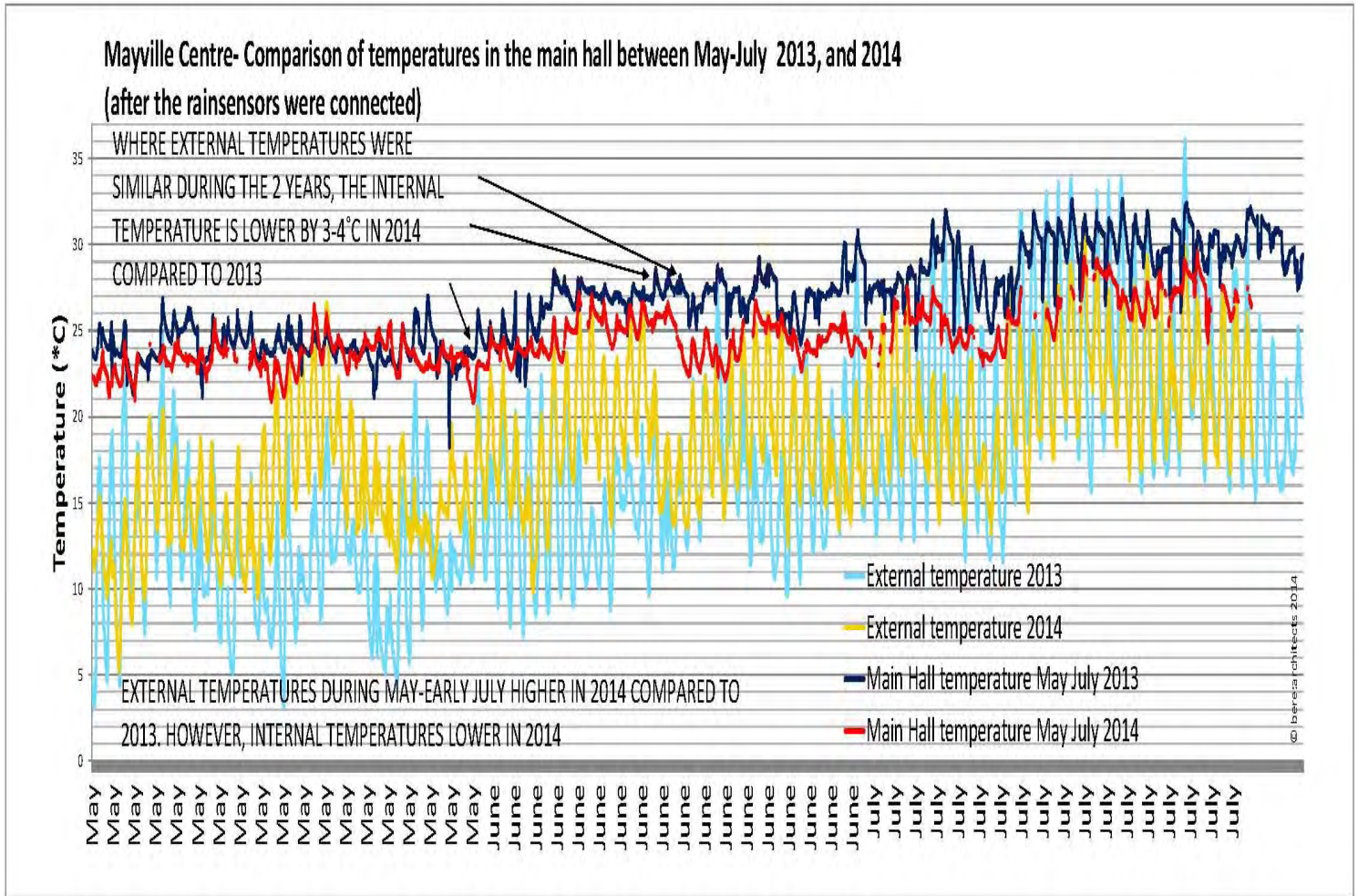

Figure 6-34 Comparison of temperatures in the main hall between May-July 2013, and 2014

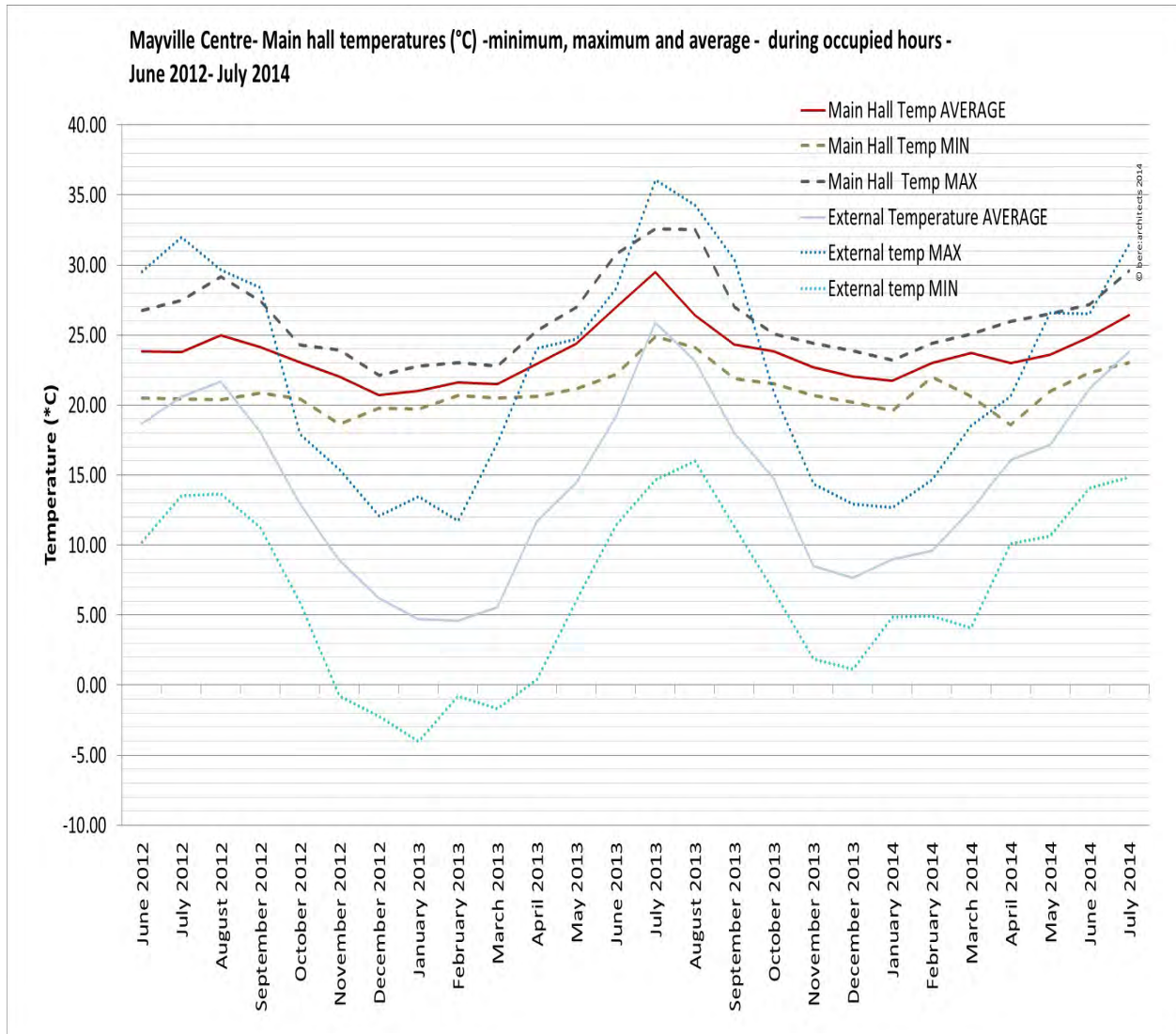

Figure 6-35 Main hall temperatures – minimum, maximum and average – during occupied hours

6.5.2.4 Carbon dioxide concentrations (ppm)

The majority of the readings were significantly better than the recommended maximum of 1500ppm (CIBSE Guide A), with occasional spikes occurring during events with large numbers of people attending. The charts below show how effectively the CO₂ is dissipated in the main hall when several activities are booked in, on typical days: ‘stay and play’ (25 people), indoor bowls (10 people), and tango (15 people & more dynamic activity than ‘stay and play’ and bowls):

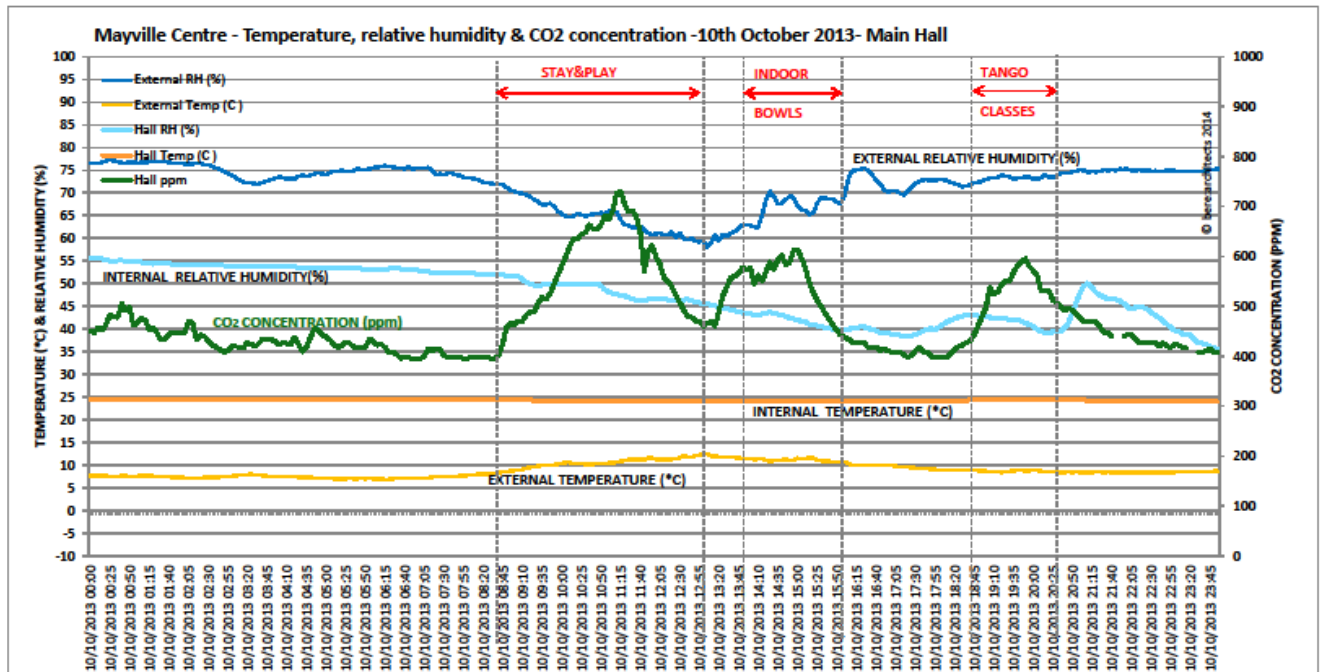

Figure 6-36 The temperature, RH and CO2 concentration in the main hall during 1 day (10.10.2013)

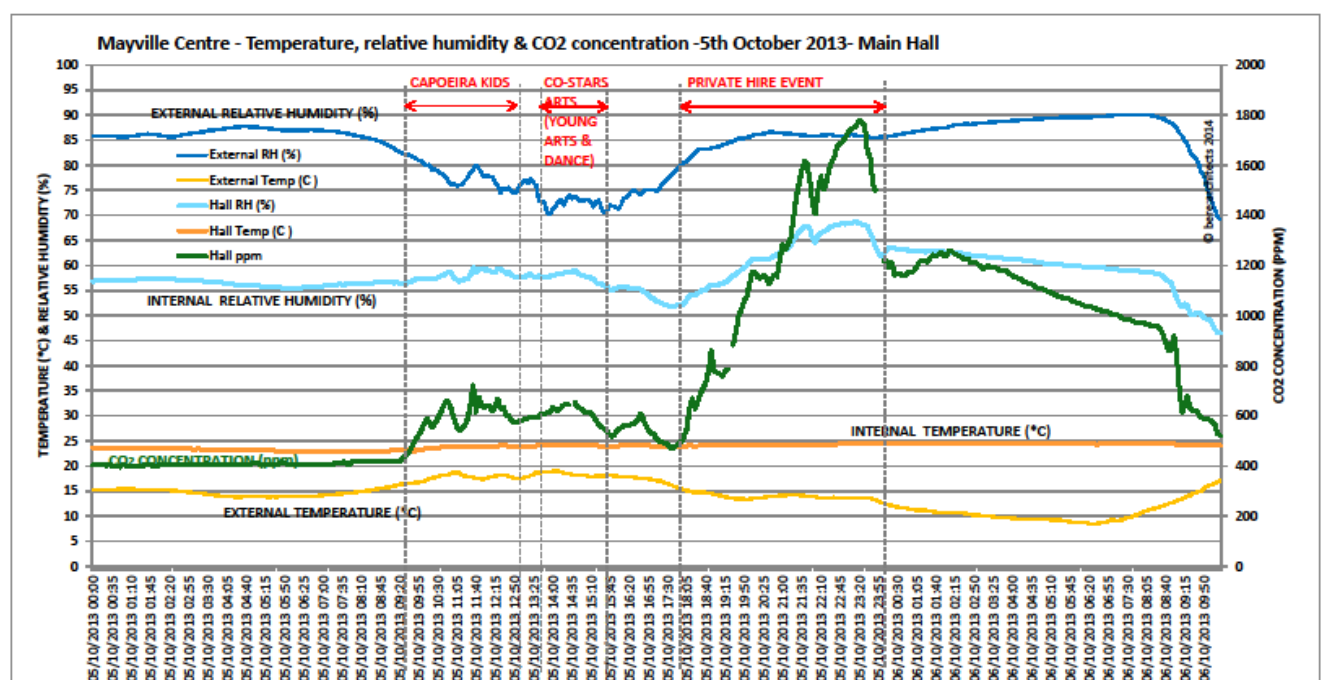

Figure 6-37 The temperature, RH and CO2 concentration in the main hall during 1 day (5.10.2013)

The analysis shows that the ventilation strategies (whether natural ventilation in the summer or mechanical with heat recovery in the winter) ensure the effective removal of CO₂ concentration in the analysed spaces. This is particularly important for the main hall where there are regular activities and events attended by large numbers of people: bowls, table tennis, and dance classes, church masses during the weekends, occasional bingo activities, lectures, baptism celebrations or funeral commemorations.

6.6 Conclusions and key findings for this section

1. All electric building, grid electricity used in the last 12 months up to July 2014: 48.8 kWh/m².year, PV generation of approx. 18 kWh/m².year, out of which a calculated 13.9 kWh/m².year have been used in the building. A total energy use of 62.7kWh/m².year in the 12 months up to July 2014, and a total of 55.64kWh/m².year in year 1, which sets a standard for community centres and other mixed-use non-domestic buildings. This compares to the raw TM46 benchmark at 190 kWh/m²year typical energy use for seasonal public buildings (community centre sub-type), a hybrid ECON19 'good practice' benchmark at 167 kWh/m².year, defined by BSRIA. The Passive House Planning Package (PHPP) design estimate was 44.4 kWh/m².year but the PHPP data entries anticipated a much lower occupancy pattern which was as agreed with the clients during design. (Note that 44.4kWh/m².yr equates to almost exactly 120 kWh/m².year primary energy – that is including UK grid transmission losses - which is the overall energy use limit that is permitted for a certified Passive House.). When the actual current occupancy of the building was entered into PHPP, the software was found to anticipate overall energy use of 56.3kWh/m².year which is very close to the actual measured energy use reported above.
2. The TM22 analysis for the year up to December 2013 indicated that the majority of the regulated loads were covered by the renewable energy generated on site, within 6% difference. This makes the Centre close to being a zero carbon building according to current regulations, even if the occupancy is higher than estimated at design stage. With some attention paid to reducing the number of servers in the building and better attention to turning off lights, it is considered by the design team that a further 6% savings would be achievable.
3. The monitoring data analysis shows that more than 85% of the energy used in the building is used for lights and small power.
4. The TM22 analysis showed that updated benchmarks are needed for mixed use community centres and that the operational energy data (design and metered) uploaded and made public on the Carbon Buzz platform can help identify and bridge the performance gap in the industry.
5. The winter strategies were found to work very well, delivering good comfort with low energy consumption. The highly insulated, draught and thermal bridge-free construction details, alongside the heat recovery ventilation system proved to work well and provide very good comfort during the winter. The implementation of summer strategies was delayed, but this summer's data showed that all spaces bar one in the building delivered summer comfort within the recommended ranges for most of the occupied hours.
6. When implemented correctly, nighttime purge ventilation provided temperatures generally lower by 3-4°C than the year before, during a hotter summer. Even so, this could be further improved, since not all passive strategies were fully implemented by users (leaving windows on tilt, effectively using the blinds).
7. With a view towards climate change and increasingly warmer summers, it is important to have robust summer strategies in place, as well as robust winter strategies.

8. Carbon dioxide levels are well within the recommended ranges and the ventilation strategy works well to dissipate the high concentrations achieved during events attracting two hundred people in the main hall.
9. Relative humidity levels indoors were generally within acceptable ranges for human health in winter and summer conditions, and no condensation was reported at any time, even in bathrooms and kitchens.

7 Technical issues

7.1 Technical issues arising after completion

During the BPE study several technical issues were signalled:

1. About twice per month, late night social events occur in the centre requiring ventilation beyond the normal hours of occupancy (7.30am-9pm). Rather than unnecessarily extending the ventilation operating hours to midnight all month for just two late bookings, it was decided to add an easily accessible ventilation run-on switch that will extend the hours of operation by up to 3 hours. This added feature is regularly used and operates correctly.
2. Issues with the quality of the contractor's sub-metering installation, as described in Section 5.2. Discovered and solved at the start of BPE monitoring.
3. Incorrect routing of a lighting control wire, as described in Section 3.5. Solved August 2014.
4. Velux opening roof light rain sensors found wrapped in plastic bags behind the metal trims. This meant night purge ventilation could not be operated until after the end of Summer 2013. Once operational (summer 2014) users experience significantly improved indoor comfort in the main hall and adjacent spaces.
5. Issues with the external blinds: UK distributor did not commission properly, leading to damage to the blinds in high winds.
6. Front door automated closing mechanism incorrectly commissioned by UK distributor. Solved in 2014 by visit from German door manufacturer who showed UK door closer distributor how to adjust the closing pressure adjustment
7. As mentioned in Section 3.1, manufacturer's fault on an air supply volume control valve.

7.2 Conclusions and key findings for this section

1. Listed above is one minor issue resolved by a small operational refinement, and one minor product failure. However there were five issues caused by product distributors or subcontractors who lacked the skills to carry out their installation or commissioning work to a reasonable standard.

8 Key messages for the client, owner and occupier

8.1 Main findings from the study, key messages to the client and occupier

The main findings during this Building Performance Evaluation Study were:

1. The building is performing well when compared to industry benchmarks for energy consumption.
2. The CO₂ performance is mostly in line with the design stage PHPP prediction. Average CO₂ level is better than the Building Regulations recommendation of 1500ppm and even when the main hall is fully occupied, the ventilation system keeps CO₂ levels well below the HSE maximum level of 5000ppm.
3. Regulated energy is close to the design prediction indicating that the systems and fabric of the building are performing as expected.
4. The actual and perceived comfort of the building was generally found to be positive and better than BUS benchmarks.
5. The Centre is mostly naturally ventilated during the summer, illustrating that acceptable comfort levels can be achieved without the high energy usage associated with air conditioned buildings. Some occurrences of peak summer time overheating were found but significant improvements were achieved by solving some commissioning issues with the natural ventilation strategy and by closer engagement of the occupants with the shading and ventilation strategy.
6. The building has no BMS system, only simple, intuitive controls. This design strategy has proved in use to be a good and robust strategy.

Key messages to the owner and occupier at the end of this study are:

1. The savings in energy bills after retrofit are impressive, particularly considering the great increase in the occupancy of the building and in the electrical appliances such as computer servers. So the building is performing very well. Most of the energy used in the building is used for lighting and small power appliances. Optimising the energy use is relatively easy to do, by ensuring the energy saving systems are maintained and working as intended and by keeping an eye on the use of the lights and small power, and improving it if possible (for instance by looking for solutions to replace the high number of servers in the building with a cloud solution).
2. The low energy systems so far seem to require low maintenance apart from six monthly filter changes for the ventilation unit.
3. Seasonal reminders to the building occupants about saving energy and improve their comfort would be beneficial: keeping the heat inside the building during the winter, not leaving the front door on

hold-open, operating a constant thermostat setting, and during the summer using the windows, rooflights, ventilation grilles and blinds to create a comfortable environment.

8.2 Lessons learnt

The main lessons learnt during this project are:

1. The Passive House approach proved to be effective in delivering a low energy community centre, with high levels of comfort. The user surveys and the energy use show that the targets the designers aimed for have been achieved.
2. As the final works relied heavily on grants and private donations (due to an unexpected loss of some funding), several items were left out of the contract and the finishes have not been of very high quality. In spite of this, the clients have been committed to the low energy agenda and this has been crucial to the success of the project.
3. The simple controls strategy for the mechanical equipment has worked out very well. The feedback displays and degree of automation were kept to minimum due to budget constraints, however the design team learned what works intuitively for users and, crucially for future projects, to continually review what is the optimal balance between automation and manual controls.
4. By contrast, the lighting controls system used at the Mayville has a closed protocol, which means that commissioning and maintenance must be carried out by the manufacturer without any competition. Bere:architects consider this to have been a mistake and in future will always ensure that any lighting controls are based on widely used, standardised European open-source protocols.
5. Softlandings – this ideally needs to be followed up each Winter, Spring and Autumn by or with the building manager and the occupants, to ensure they are aware of the best way to maintain good comfort in the building.
6. The minimum sub-metering required by building regulations to monitor the energy systems was not fully implemented by the contractor, and without the funding of this research project, this would not
7. have been discovered, let alone remedied. Wider experience suggests that sub-metering of buildings in the UK is often defective. We suggest that an independent 3rd party electrician could be required to check the sub-metering of every building before sign off, to check that it meets the requirements of the Building Regulations, in order to have an accurate means of measuring building performance.

9 Wider lessons

9.1 Lessons from the project

9.1.1 Passive House works

The Passive House Planning Package (PHPP) was found to be a successful and relatively accurate method of predicting the energy use and comfort conditions associated with the specified design.

A robust fabric first design and a simple, rational services design can ensure a building will perform very well even if the assumptions used at design stage in PHPP will change during the lifetime of the building, in terms of occupancy levels and the functions of interior spaces. (These variations can also be tested in the PHPP software).

9.1.2 Air tightness is not excessively difficult to achieve

Once again this project demonstrates that with care in design and construction, exceptionally draught-free buildings can be achieved without excessive difficulty. This building has a measured air tightness over 10 times better than UK Building Regulations and this was achieved at the first attempt by a contractor that had never attempted this before.

9.1.3 Controls should be kept simple – avoid BMS systems

Bere:architects would recommend that in low energy non-domestic projects controls are kept simple by using product manufacturer's own controls and taking advantage of the benefits of open source European standard control protocols.

9.2 Messages for other designers

9.2.1 Overcoming the Knowledge Gap

This was Bere Architects' first non-domestic Passive House retrofit. The other Passive House certified buildings that the practice had experience of at the time were all new builds of timber frame construction. The solid masonry construction of the Mayville Centre was ideal for the use of external insulation and a render system. Previously acquired knowledge regarding Passive House construction and avoiding thermal bridges was used in the design on this project, through the use of specific software (such as Heat 2) to check critical junctions. We learned about insulating the existing concrete basement floors and used our previous experience with thermal bridge isolators (Schoeck) for the South basement walls and balcony.

9.2.2 Overcoming the Construction Skills Gap

The project was delivered by a main contractor that had not previously delivered a certified Passive House; but with the active involvement of the architect on site, the project was a success.

To meet the ambitions of Passive House design, construction teams must commit to much higher levels of construction quality than is the current norm in the UK. A key requirement to achieve this is commitment to careful work. A successful Passive House requires a meticulous and careful contractor. To give the best chance of success, the contractor should employ an 'airtightness champion' to maintain quality control on site.

Only under rare conditions is a Design and Build contract considered suitable by the design team at this point for delivering a Passive House project in the UK because in 2014 there seem to be very few UK contractors with the necessary skills to lead a successful Passive House project. A traditional form of contract administrated by an architect or specialist designer with Passive House expertise is normally essential.

If the main contractor employs the services of a subcontractor with specialist expertise in Passive House to work alongside a directly employed main contractor labour force, this is a proven way to embed skills within a traditional UK construction team that is prepared to embrace modern and high quality methods of construction.

9.2.3 Quality Control

Any system is only as good as its weakest link. It is the design team's view that the resilience of this building, even when user habits were unexpected or sub-optimal with respect to achieving the best performance, has been dependent on meeting the full, holistic, quality assurance requirements necessary for a certified Passive House building.

There were some problems with the commissioning of several systems (light controls connecting PIR and daylight sensors, rain sensors for rooflights, GSHP direct heater, sub-metering, external blinds). The lesson learnt was that all low energy features which may be new to the contractor and sub-contractors need to be carefully checked, from design and then on to site and completion. This was not always possible at the end of this project due to a dispute over money after some funding was lost. However through persistence of the design team there are very few remaining concerns.

It is Bere:architects' view that a contract which enables a diligent architect to control the quality of workmanship on site is the arrangement that is most likely to achieve good results, whether or not Passive House methods are used, but especially if high standards of workmanship are required for successful delivery of the project objectives. For similar reasons, 'Contractor design and build' contracts are not considered to be a good modus operandi where the largest proportion of the advanced construction knowledge lies with a knowledgeable architect.

9.2.4 Contract administration

Even with a good contractor it is bere:architects' opinion that a knowledgeable Passive House professional is required to guide the process successfully through to completing a Passive House contract on site. Moreover, the traditional role of managing a construction contract may be insufficient to deliver a successful Passive House and a more 'hands-on' approach may be needed from a professional who has expertise in advanced construction skills.

9.2.5 Airtightness

Air tight construction minimises infiltration heat loss and contributes to comfortable, draught-free spaces. Draught-free construction is an important factor necessary to achieve the comfort, performance and resilience of a certified Passive House.

The resilience of this building has in part depended on meeting the Passive House airtightness requirement of 0.6ACH @50pa pressure. The results of the monitoring of this building illustrate that air tight construction, which is beneficial for comfort (it ensures there are no cold draughts) and crucial to minimise infiltration heat losses in winter, when matched by an appropriately designed, installed and commissioned heat recovery ventilation system has provided a vital contribution to this building's comfort and in-use performance.

Good airtightness depends upon design. The line of air tightness must be strategically designed and clearly demarcated (see <http://www.bere.co.uk/research/airtightness-report-a-practical-guide>).

Good airtightness also depends upon careful attention to build quality combined with some easily understood air tightness techniques. These techniques are not difficult to achieve if the correct materials are used and care is taken by all operatives, led by managers who are knowledgeable about advanced construction processes. (see <http://bere.co.uk/research/airtightness-report-a-practical-guide>).

9.2.6 Ventilation design

While Part F of the Building Regulations requires good ventilation rates, there is a loophole in that the Building Regulations do not require that the ventilation rate of every room in a building is individually calculated and commissioned. This allows ordinary buildings to be built with inadequate ventilation in some spaces, and allows faulty ductwork to go unnoticed. It is a requirement of the Passive House certification process that all rooms must be individually commissioned to meet requirements and overall intake and exhaust figures must be compared to check for defective ductwork. Expert commissioning is needed. Andrew Farr of the Green Building Store provided the necessary expertise in ventilation system commissioning on this project.

A well-installed and commissioned heat recovery ventilation system, combined with a good airtightness result, played an essential role in the energy and CO₂ savings and in delivering a comfortable environment with optimal relative humidity and CO₂ levels.

9.2.7 Ventilation performance

The simple, single zone ventilation system delivers constant winter ventilation with minor control refinements for areas of variable occupation. An extra 'boost' button was installed at the bottom of the main stairs, to be used by the Centre managers to extend the ventilation running time outside the normal occupancy hours, when there are events happening in the Centre late in the evenings. Lesson learned: extend ventilation for 'out of hours' events for non-domestic buildings. Consider manual switching or better still; presence detection.

9.2.8 Fabric tests

Several fabric tests were carried out on the building, including a thermographic survey, and an air-tightness blower door test. The fabric tests resulted in impressive results that underscore the accuracy of the Passive House Planning Package (PHPP) as a design tool that closes the performance gap between design and actual use.

9.2.9 Window performance

Tilt and turn multi-point window locking mechanisms have been common throughout Europe for many years, where people of all ages are generally familiar with the mechanisms since childhood. Likewise, the occupants of this building quickly warmed to better window and door systems including the numerous practical and maintenance advantages of inward opening tilt and turn windows.

9.2.10 Occupant surveys

The Mayville Centre achieved above average user ratings as recorded in the BUS study of the permanent users. The transient survey results were also above average.

9.2.11 Monitoring

There is still a very limited number of low energy Community Centres in the UK making it difficult to compare the Mayville results with a benchmark. However an overall result of 62.7 kWh/m² in the second year indicated that the Centre is performing with results that are significantly better than current benchmarks.

The BPE research project has helped demonstrate the advantages of an intelligently designed, quality-assured approach.

9.2.12 Installation and commissioning checks

1. There are strong merits in keeping designs simple, robust and above all intuitive. The purpose of any technology, and its method of operation, should either be crystal clear to building users, or should be robustly automated with simple, standard devices (not specially programmed building management systems).
2. There is a need to develop cheap and simple warning devices such as prominent red or green lights to warn if equipment is switched off or on incorrectly, or if filters need to be changed. Further research and development in this field is, we believe, urgently required.
3. The data that was collected over the two year research project showed how the occupants interacted with the controls and how they used the building. Further research will be aimed at achieving the most successful balance between user control and automation in future projects.
4. The ventilation system was found to be faultless in design, installation, commissioning and use, delivering a well-ventilated indoor environment alongside excellent energy and CO2 savings.
5. Avoid the knowledge-gap between designer and user by using Soft Landings techniques including clear and carefully thought out user guides that carefully explain your design logic. If you cannot easily explain your logic, systems may be too complicated to be used effectively.
6. A key objective of the design team was to avoid overly-complicated or bespoke control systems such as Building Management Systems which are over-reliant on the cooperation of expensive computer programmers. The team successfully used manufacturer's standard controls, using equipment that is designed to work cooperatively with other equipment in a clear and simple manner using un-modified product manufacturers' standard controls. This design strategy has been found to produce reliable results in practice. By contrast, a TSB BPE conference on non-domestic buildings in Coventry found a broad consensus amongst designers that BMS systems were problematic. This project shows that building controls need not be as complicated as some designers believe is necessary.

9.3 Dissemination

1. The findings of this BPE study are relevant and could be very helpful to several important stakeholders in the built environment:
2. The design team will continue to disseminate the results of this BPE study via presentations, lectures and conferences aimed at architects and consultants interested in low energy buildings, performance in use, and closing the gap between design and the actual performance of the buildings. The team frequently shares their design experience in events such as: RIBA talks, Ecobuild, Passive House Conferences (UK and International), AECB conferences, Carbon Buzz website, articles in architecture and construction oriented journals (Architects Journal, BSRIA magazine, RIBA Journal, etc).

3. Contractors: the design team worked closely on site with the contractors and sub-contractors, disseminating information about how to use Passive House techniques, and frequently perform training sessions on airtightness and windows installation.
4. Manufacturers and suppliers: the design team kept in touch and gave feedback to the main systems' manufacturers, receiving advice when the systems happened to be malfunctioning.
5. Clients and occupants, through regular feedback regarding the energy use of the building based on the monitoring data.
6. Academics and students, who are analysing the data and producing reports which stand as evidence to how low energy buildings are performing. The team has worked with UCL and BSRIA on this project, and several engineering and architectural magazines articles have detailed the performance of this first non-domestic Passive House retrofit project. The team also intends to continue to present their BPE projects and the findings of the studies to students in architecture and built environment in major UK universities, through talks and site visits.
7. The wider public, via the design team's website, blog and on their research and films pages online, and also by engaging with the local communities and schools, organising tours and talks.

9.4 Conclusions and key findings for this section

1. Bere:architects' research objectives in the Technology Strategy Board funded Building Performance Evaluation studies of their first four Passive House building types was to investigate whether the low energy, sustainable, approach to refurbishment and new builds that the practice had been taking since around 2000 was indeed a worthwhile direction; if the results matched our design intentions, and if we could really achieve the deep energy savings and carbon reductions that we were aiming for.
2. The results of two years' research on all four buildings have found the design methodology working well in the UK context. This Mayville retrofit was found to greatly improve the comfort of occupants compared to the pre-retrofit building while providing excellent conditions for health, and reducing the overall energy consumption eight or ten-fold compared to the existing building.
3. The energy savings from the Mayville Community Centre, even if only £20,000 per year compared to the building before retrofit, will save more than £1million in energy costs over the next 50 years without even taking into account the impact of inflation.
4. The size of the energy savings that have been found in this research project indicate that the additional build costs of 3 – 8% reported in appendix 10.17 will be repaid by energy savings in as little as three years.
5. This research project has found overall energy savings, where all other factors such as occupancy remain the same, has exceeded 80%. The architects believe that this result is significant because if it

could be replicated widely, this could be relevant for UK energy policy, particularly around the ability of renewables to meet peak winter energy demand.

6. The results of this research prove that these benefits can be achieved by well-trained British construction teams at their first attempt. The essential air-tightness requirements are easily met or exceeded by well-trained and diligent teams. At the first attempt, installing windows, vapour control layers and heat recovery ventilation can be a success if either the architect or the contractor is knowledgeable (only one party needs to be) and is prepared to take a hands-on approach.
7. The research team found that the total yearly electricity consumption of the building was approximately 62.7 kWh/m² year, out of which approximately 48.8 kWh/m² year was provided by the grid, and an estimated 13.9 kWh/m²year were used from the electricity generated by the photovoltaic panels. This compares to the 44.4 kWh/m² total energy (electricity) consumption assessed using the Passive House Planning Package (PHPP) software during design stage, when the occupancy level envisaged by the client was lower. This also compares with the TM46 benchmark at almost 200kWh/m² year and a hybrid Econ 19 user-specified benchmark tailored to match the mixed use of the building at around 160kWh/m²year.
8. Similar and consistently strong results have been found in both of the design team's other two Building Performance Evaluation studies of Passive House buildings (Larch & Lime houses in Ebbw Vale, Wales and the Camden House in London). The results indicate that in these cases, Passive House buildings achieve very low heat loss levels, and that Passive House design appears to be robust enough to achieve low overall energy consumption even with unexpected occupant behaviour.
9. These BPE studies found that the Passive House Planning Package (PHPP) is a good design tool. In spite of being a steady-state tool, in these cases it managed to anticipate accurately the energy performance of domestic and non-domestic buildings.
10. The design team wishes to express the hope that the knowledge gathered in the three Technology Strategy Board BPE studies referred to above will encourage a step change in the way buildings are designed and built in the UK, so that extremely low energy buildings with excellent comfort evolve from being 'prototypes' to becoming the 'norm' in the UK built environment.

10 Appendices

- 10.1 Appendix 1 - Passivhaus Certificate - Mayville Community Centre
- 10.2 Appendix 2 - Mayville PHPP Verification page revised hours of use
- 10.3 Appendix 3 - Thermal bridging analysis
- 10.4 Appendix 4 - Thermography report
- 10.5 Appendix 5 - Fabric performance report
- 10.6 Appendix 6 - ALDAS Mayville Acceptance Post-Improvement Air Leakage Test
- 10.7 Appendix 7 - Submetering report
- 10.8 Appendix 8 - Monitoring Equipment Installation report
- 10.9 Appendix 9 - Client Soft landings workshop
- 10.10 Appendix 10 - BUS link and explanation
- 10.11 Appendix 11 - TM22 report
- 10.12 Appendix 12 - Mayville community centre user guide
- 10.13 Appendix 13 – Interview with an MCP board member
- 10.14 Appendix 14 – Telephone interview with the Site manager & Electrical sub-contractor
- 10.15 Appendix 15 – Interview with the Centre managers
- 10.16 Appendix 16 – Month 18 energy use and environmental conditions

report

10.17 Appendix 17 - Cost comparison report

10.18 Appendix 18 - Occupancy before and after retrofit

10.19 Appendix 19 - Energy consumption diagram

10.20 Appendix 20 – Interview with the Centre manager - November 2014